

POWER

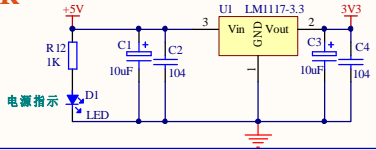

CPU

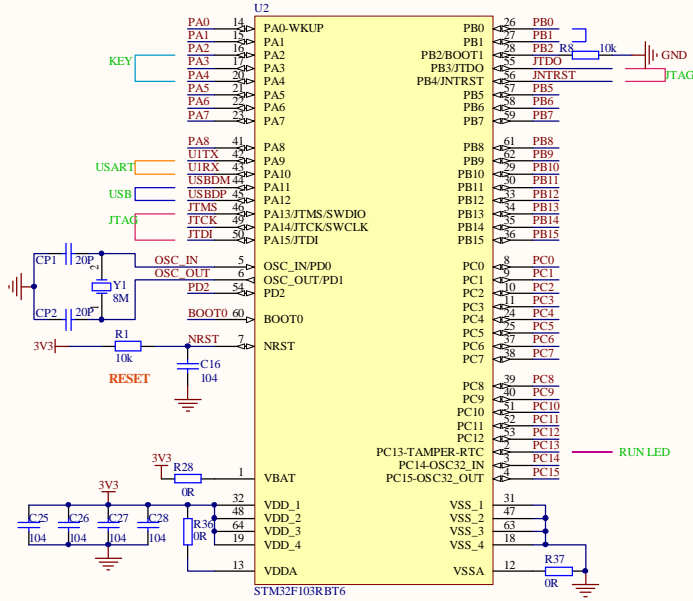

KEY

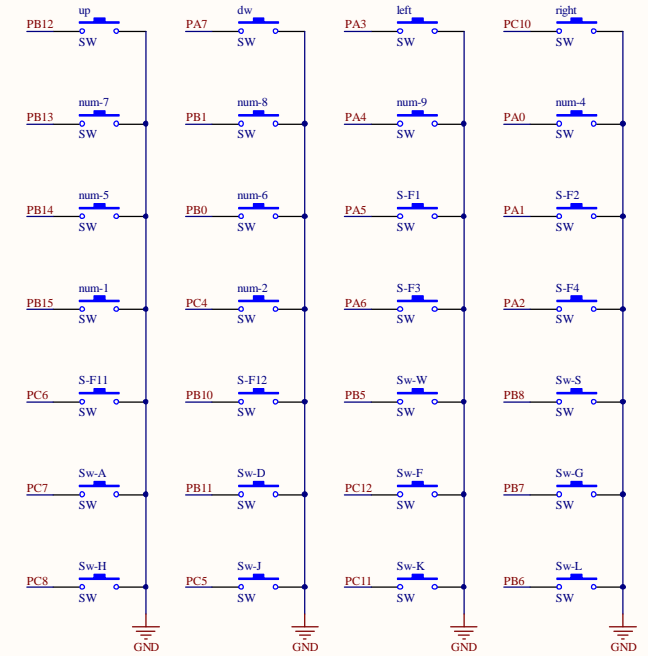

USB-Protect

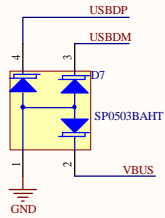

BOOT

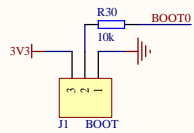

USB-Device

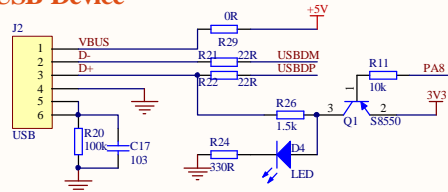

RUN LED

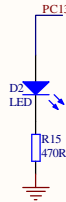

JTAG

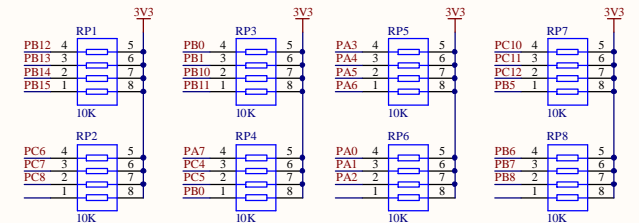
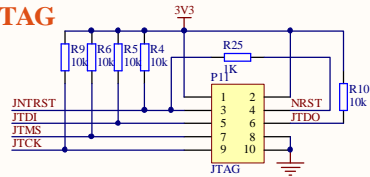

Title		
STM32 USB键盘定制		
Size	Number	Revision
A3		
Date:	Sheet of	
File:		