

# Compact Integrated Antennas

## Designs and Applications for the MC13191/92/93

### 1 Introduction

Good antenna design is the most critical factor in obtaining good range and stable throughput in a wireless application. This is especially true in low power and compact designs, where antenna space is less than optimal. However, several compact, cost efficient, and very effective options exist for implementing integrated antennas.

To obtain the desired performance, it is required that users have at least a basic knowledge about how antennas function, and the design parameters involved. These parameters include selecting the correct antenna, antenna tuning, matching, gain/loss, and knowing the required radiation pattern.

This note will help users understand antenna basics, and aid in selecting the right antenna solution for their application.

### Contents

<b>1 Introduction</b> .....	<b>1</b>
<b>2 Antenna Terms</b> .....	<b>2</b>
<b>3 Basic Antenna Theory</b> .....	<b>2</b>
<b>4 Impedance Matching</b> .....	<b>6</b>
<b>5 Miniaturization Trade-offs</b> .....	<b>13</b>
<b>6 Potential Issues</b> .....	<b>14</b>
<b>7 Recommended Antenna Designs</b> .....	<b>14</b>
<b>8 Design Examples</b> .....	<b>16</b>

## 2 Antenna Terms

Antenna Gain	A measure of how well the antenna radiates the RF power in a given direction, compared to a reference antenna, such as a dipole or an isotropic radiator. The gain is usually measured in dB's. A negative number means that the antenna in question radiates less than the reference antenna, a positive number means that the antenna radiates more.
Decibel (dB)	A logarithmic scale used to represent power gain or loss in an RF circuit. 3 dB is a doubling of the power, -3 dB is half the power. -6 dB represents half the voltage or current, and quarter the power.
Radiation Resistance	The part of antenna's impedance which produces radiated power. The measured impedance of an antenna is comprised of radiation resistance and loss.

## 3 Basic Antenna Theory

Every structure carrying RF current generates an electromagnetic field and can radiate RF power to some extent and likewise an external RF field can introduce currents in the structure. This means that theoretically any metallic structure can be used as an antenna. However, some structures are more efficient in radiating and receiving RF power than others. The following set of examples explains this concept.

Transmission lines (striplines, coaxial lines etc.) are designed to transport RF power with as little radiation loss as possible because these structures are designed to contain the electromagnetic fields. To obtain any appreciable radiation from such a structure, requires excessively high RF currents which causes low efficiency due to high losses. Likewise, the ability to introduce RF currents into the structure is of importance, described by the feed point impedance. If the feed point impedance is very high, low, and/or highly complex, it is difficult to introduce RF current with good efficiency.

The antenna structure should be of reasonable size compared to the wavelength of the RF field. A natural size is half a wavelength, which corresponds to approximately 6 cm at the 2.4 GHz ISM band. This size is effective because when fed with RF power at the center point, the structure is resonant at the half wave frequency. Reducing the size below 6cm tends to make the antenna less visible to the RF field and not resonant which causes low efficiency. Not all structures make an efficient antenna.

Numerous structures have been devised that provide good efficiency and impedance match, but most of these are derived from a few basic structures. A short description of these basic antennas, and some good advice on how to implement these with success is provided later in this note.

This note does not include complicated formulas concerning antenna theory because it is beyond the scope of this note. The intention of this note is to provide basic information about how antennas work, which should allow users to achieve reasonable performance with a minimum number of attempts.

If users are interested in performing complex calculations and antenna simulations, they should consult the abundant and widely available literature concerning antenna theory and design. Note that simply copying an existing design does not necessarily ensure reasonable performance. A lot of external factors affect antenna tuning, gain, radiation patterns, etc. An antenna tuned for one set of environmental factors may not perform at all if put into a new environment, and may require a lot of tuning to achieve even reasonable performance.

## 3.1 Basic Antenna Variations

### 3.1.1 3.1.1 Dipole Antenna

The dipole is one of the most basic antennas. The dipole is a straight piece of wire cut in the center and fed with a balanced generator or transmission line. As previously stated, this structure is resonant, or non-reactive, at the frequency where the conductor length is  $1/2$  wavelength. For the ISM band, this length is approximately 6 cm or about  $2\frac{1}{2}$  inches. At this length, the dipole shows resonance, the feed impedance is resistive, and is close to 73 Ohms. This also holds true for a very thin wire in free space.

Total Length is Approximately  $\frac{1}{2}$  Wavelength  
(At 2.4 GHz, Length is Approximately 6 cm)



**Figure 1. Basic Dipole**

A practical dipole of some thickness, loaded with different dielectric materials (PCB etc.), and perhaps relatively close to ground, shows resonance at a slightly shorter length than calculated, and the radiation resistance drops somewhat. For dipoles not too close to ground, the shorting factor is typically in the range of 5-20%, the shorter being more heavily dielectric loaded, and radiation resistance is in the range of 35-65 Ohms.

This dipole setup exhibits a relatively good match to a 50 Ohm generator, but the feed is differential. A small ceramic balun can be used for single-ended feed. The bandwidth is typically 2-5%, depending on the return loss required. The radiation pattern in free space is doughnut-shaped, with pronounced dips along the direction of the wires. To fill out these dips, the outer ends of the antenna can be bent at a 45 degree angle. Several configurations are possible, including the “broken arrow” shape. Any materials close to the antenna can distort the radiation pattern.

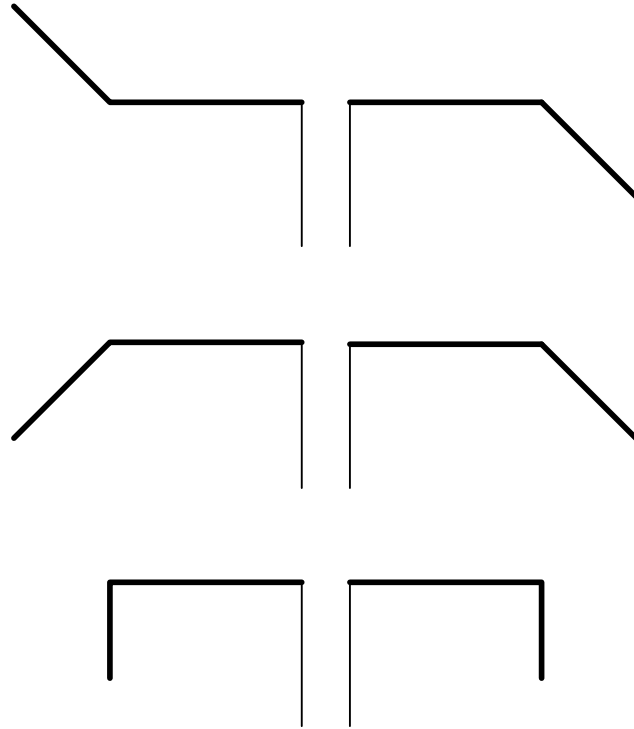

**Figure 2. Dipole Shapes to Improve Omnidirectional Characteristics**

To reduce the size of the dipole, several options exist:

- Replacing some of the wire length with loading coils
- Bending the dipole ends back on the dipole
- Folding the dipole into a meander pattern
- Hairpin or coil loading of the center
- Capacitive loading of the dipole ends

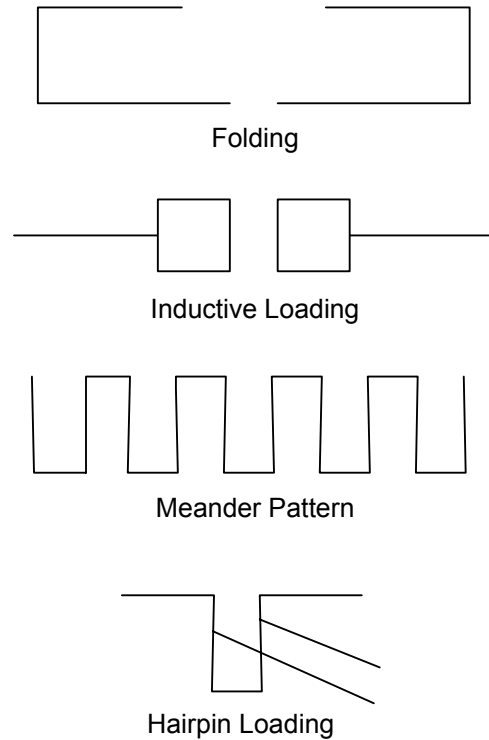

**Figure 3. Dipole Loading Examples**

In general, the smaller the antenna, the lower the radiation resistance and the lower the efficiency. The antenna should also be removed somewhat from the ground plane, preferably at least  $\frac{1}{4}$  wavelength (3 cm) but not less than 1 cm. Sometimes a loading technique is employed where the dipole ends are bent close to the ground plane, or even loaded with small capacitors to ground. This technique shorts the dipole considerably but causes heavy RF currents to flow in the ground plane, resulting in low efficiency. Often some of the other loading techniques result in better performance.

## 4 Impedance Matching

For heavily loaded antennas and antennas close to ground, the radiation resistance may deviate considerably from 50 Ohms which causes a poor match. An Inductive/Capacitive (LC) matching network may be employed, but better efficiency is possible by raising the feed impedance.

These techniques may also be employed if an impedance higher than 50 Ohm is required.

The current and voltage distribution on a dipole is such that the impedance is low in the center and raises towards the ends. By tapering the dipole at some distance from the center, an appropriate match can be found. The tapering may take the form of Gamma, Delta or Capacitive tapping as shown in Figure 4. This allows for matching impedances from 2 up to 300 Ohms. Some loading may be required to take out the reactance introduced by the tapering, or the antenna could be slightly offset tuned to compensate for the added reactive component.

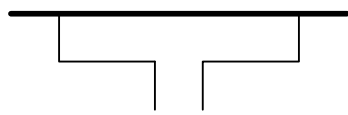

Gamma Impedance Match

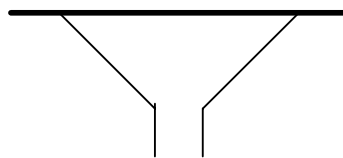

Delta Impedance Match

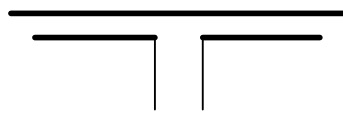

Capacitive Impedance Match

**Figure 4. Impedance Matching**

Another approach is using the folded dipole. This is where two parallel wires are placed closely together. Due to the tight coupling, the current distribution is approximately proportional to the surface area of each wire. This means that in two equal wires, the current in the feeding wire is approximately half the value of the wires together. Half the current at the same power means twice the voltage, or four times the impedance of 73 Ohms (292 Ohms). In practice, the impedance is somewhat lower, as in the normal dipole case. however, by changing the relative wire diameter, or even introducing several wires, it is possible to tune the impedance from less than 100 Ohms to several hundred Ohms.

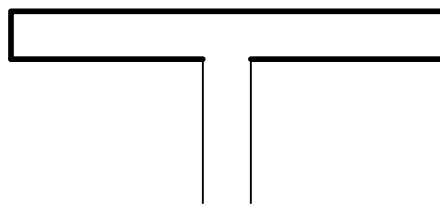

**Figure 5. The Folded Dipole**

All the different dipole types, loading techniques, and feeding networks total up to an enormous amount of possible combinations, each with its own advantages and disadvantages. Selection of the correct design for your application is best found using case-by-case assessment.

## 4.1 Monopole Antennas

If one part of a dipole antenna is removed and replaced by an infinite ground plane, the remaining half of the dipole “mirrors” itself in the ground plane, much in the same way that one sees their own reflection in water.

For all practical purposes, the monopole behaves as a “half” dipole. That is, it has the same doughnut shaped radiation pattern, the radiation resistance is half that of the dipole (37 Ohm), it can be bend and be folded like the dipole, and the same loading and feeding techniques can be applied.

However, one very important difference remains in that the antenna feed point is not balanced, but single ended. Because of this and because most RF circuits are of the unbalanced type, this antenna type has been immensely popular and a lot of variations of the monopole theme exist, most designed to match 50 Ohms.

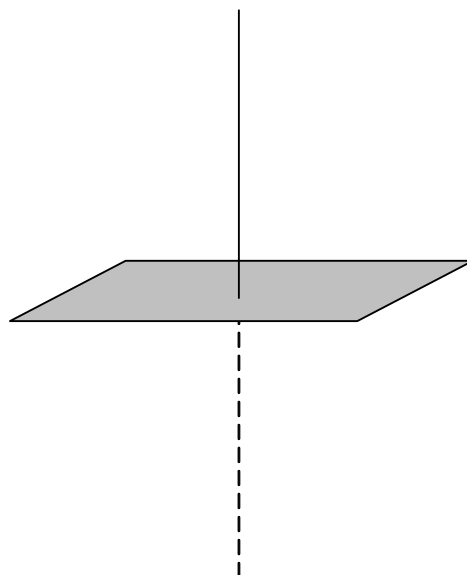

**Figure 6. Monopole Above a Ground Plane, Showing the “Mirror” Antenna**

It is important to note that the “whip” is only half the antenna and that the remainder is made up of the ground plane, or counter weight, as it is sometimes called. In a practical application, the ground plane is often made up of the remainder of the PCB (ground and supply planes, traces, and components).

The ground plane should be a reasonably sized area compared to the antenna, and should be reasonably continuous. If a monopole is used on a very small PCB, perhaps even with only a small area of copper, efficiency suffers, and the antenna is difficult to tune. Components and tracks introduce additional losses and affect the feed point impedance.

As for the dipole, resonance is obtained at a length slightly shorter than one quarter wavelength, typically 5-15% shorter. Typical lengths are slightly more than an inch or two or 3 to 5 cm. The radiation resistance is caused by bending the antenna, and like the dipole, the marked dip in the radiation pattern can be eliminated. By bending the antenna closer to ground, the radiation resistance and efficiency drops, so the antenna should not be placed too close to ground. Like the dipole, the monopole can also be folded and bent around corners, if board space requires this, or it can be loaded with series coils.

Of the many variations that exist, the following sections highlight the most common.

### 4.1.1 PCB Whip, Quarter Wave Monopole, or Quarter Wave

If board space allows, a full-size quarter wave antenna is quite efficient and often provides a reasonable match to a 50 Ohm system. Slight folding or bending of the ends has negligible impact on performance.

### 4.1.2 Open Stub, Tilted Whip

If the monopole is bent and traced along the ground plane, it will be more compact and the null in the radiation pattern is partly eliminated. The antenna should not be too close to ground, preferably not closer than  $1/10$  wavelength (1 cm), or efficiency suffers too much. At this close spacing, the radiation resistance is so low (in the order of 10 Ohms) that a matching network is usually needed. If the monopole is very close to ground, it resembles a transmission line, with little or no radiation at all.

### 4.1.3 The F-Antenna

The F-antenna can be thought of as a tilted whip, where impedance matching is done by tapping the antenna at the appropriate impedance point. Because this antenna is reasonably compact, has an omnidirectional radiation pattern, good efficiency, and is very simple, it is used extensively in applications, including the mobile communications business. It should be noted that the currents in the ground leg are high, and that a good sized ground plane is necessary to provide good efficiency.

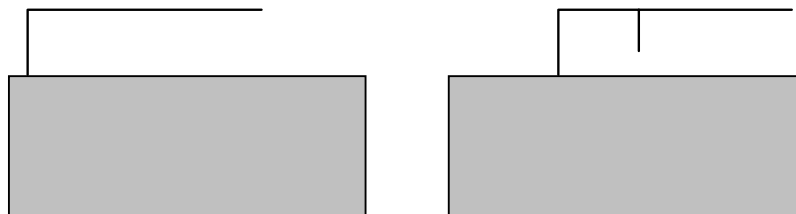

Figure 7. Tilted Whip and F - Antenna (Note the Ground Plane Area)



#### 4.1.4 The Helix

If a quarter wavelength is coiled up, a very compact antenna can be made which still has reasonable efficiency. Some experimentation may be required to find resonance, because the length of the wire is not exactly related to a quarter wavelength. This type of antenna is very popular at lower frequencies.

#### 4.1.5 The Spiral

A spiral antenna, with the windings in one plane like a pancake, is well suited to be implemented on a PCB. Performance is similar to the helix.

#### 4.1.6 The Meander Antenna

The meander antenna or meander pattern, is an antenna with the wire folded back and forth where resonance is found in a much more compact structure than can otherwise be obtained.

The meander, spiral, and helix antennas are similar in that resonance is obtained in a compact space by compressing the wire in different ways. In all three cases, the radiation resistance, bandwidth, and efficiency drops off as size is decreased, and tuning becomes increasingly critical. Impedance matching can be implemented by tapping, as in the F-antenna. The meander and helix antenna, or a combination of these two, are easily implemented in a PCB, and many chip antennas are based on these types of antenna.

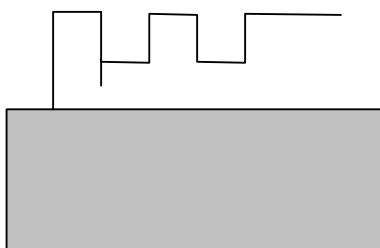

Figure 8. Meander Pattern (Tapped for Impedance Match)

## 4.2 Loop Antennas

Loop antennas can be divided in two groups:

1. Half-wave antennas
2. Full-wave antennas

The term wave refers to the approximate circumference of the loop.

### 4.2.1 Half-wave Loop

The half wave loop consists of a loop approximately half a wavelength in circumference, with a gap cut in the ring. It is very similar to a half-wave dipole that has been folded into a ring and much of the statements about the dipole apply to the half-wave loop. Because the ends are very close together, there exists some capacitive loading, and resonance is obtained at a somewhat smaller circumference than expected. The feedpoint impedance is also somewhat lower than the usual dipole, but all the usual feeding techniques can be applied to the half-wave loop. By increasing the capacitive loading across the gap, the loop can be made much smaller than a half wavelength. At heavy loading, the loop closely resembles a single winding LC tuned circuit. The actual shape of the loop is not critical. It can be shown that the efficiency is determined by the area enclosed by the loop. The half-wave loop is popular at lower frequencies. However, at higher frequencies, the tuning capacitance across the gap becomes very small and critical.

### 4.2.2 Full-wave Loop

As the name implies, the full wave loop is approximately one wavelength in circumference. Resonance is obtained when the loop is slightly longer than one wavelength, typically 10-15% longer. The full wave loop can be thought of as two end-connected dipoles. As is with the half-wave loop, the shape of the full wave loop is not critical, but efficiency is determined mainly by the enclosed area. The feed impedance is somewhat higher than the half-wave loop, typically around 120 Ohms.

Loading can be done by inserting small coils or hairpins in the loop, thereby reducing the size. As is with the dipole and half-wave loop, there exists numerous ways for impedance matching, including gamma match and tapering across a loading coil or hairpin. The main advantage of the full-wave loop is that it does not have the air gap in the loop, which is very sensitive to load and PCB capacitance spread.

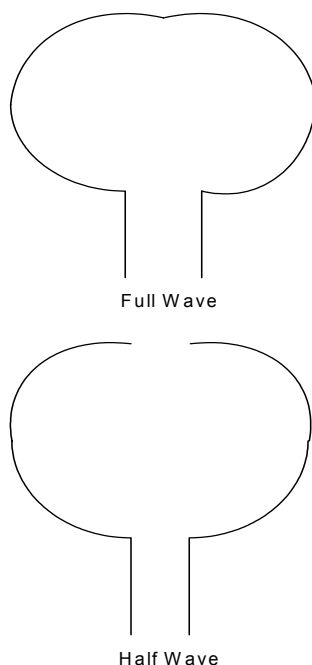

**Figure 9. Half-wave and Full-wave Loops**

### 4.2.3 Slot Antennas

Slot antennas are used extensively in aircraft and radar applications. The basic slot antenna is a half wave slot cut in a conducting sheet of metal. The feed point is across the center of the slot and balanced. The feed impedance is high, typically several hundred Ohms. Because the slot antenna is the opposite of a dipole, that is, a non-conducting slot in a sheet of metal, as opposed to a conducting rod in free air, the slot antenna shows similarities to a dipole but also exhibits interesting differences as well.

- The feed point is across the center, instead of in series, so the feed point impedance is high instead of low
- E and H fields are switched, so that the polarity is opposite
- A horizontal slot is equivalent to a vertical dipole
- The slot antenna may be of interest, if the RF unit has to be placed in a metal enclosure, where the slot antenna could be made in the enclosure itself
- If the slot antenna is cut in the center, a quarter wave slot antenna is created, which is equivalent to the monopole
- Impedance matching can be done by tapping across the slot close to the shorted end

The slot antenna could be used if a metal enclosure is required, or if considerable board area is available. If the slot antennas are implemented in FR4 PCB, considerable dielectric loading occurs which causes the physical length to be shorter than expected.

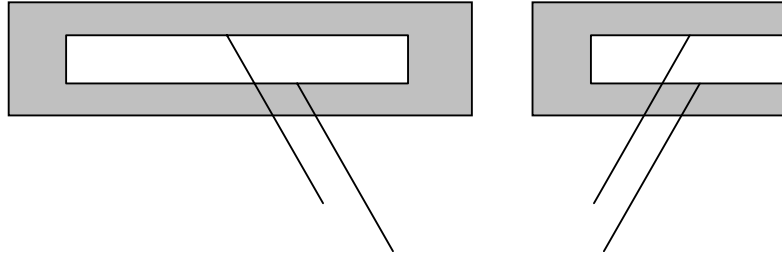

Figure 10. Half-wave and Quarter-wave Slot Antennas

#### 4.2.4 Patch Antennas

Patch antennas are a group of antennas with a very low profile and are capable of working very close to a ground plane. However, they require a fair amount of board space. The radiation pattern may be omnidirectional or unidirectional. A few examples are shown, but design and tuning is not straightforward and is best left to an experienced antenna engineer. Some types of chip antennas that show unidirectional characteristics are of this design.

#### 4.2.5 Chip Antennas

Many different chip antennas are available commercially. To many, these antennas seem to work for no apparent reason, but careful investigation reveals that most of these antennas are based on a helix, meander, or patch design. To ensure proper operation it is very important to follow the manufacturer's recommendations regarding footprint, ground areas, and mounting of the chip antenna. The "keep out" area around the antenna is especially important. Even following the recommendations does not always guarantee good performance due to de-tuning by nearby objects. It is to be expected that fine tuning of the antenna and/or a matching network is required to ensure satisfactory performance. Because chip antennas normally, but not always, use a ceramic material with higher dielectric constant and lower loss than the usual FR4, it is possible to make smaller antennas with reasonable efficiency.

The efficiency is not exceptionally high, typically in the range of 10-50%, which corresponds to 3-10 dB loss (-3 to -10 dBi). The lower number being inferior products with high inherent losses. As already stated, buying a chip antenna does not guarantee good performance. However, they do provide the smallest antenna solution possible but the size reduction comes at a cost both in performance and pricing.

If a slightly larger PCB area is available than is required by the chip antenna, and the "keep out" area can be allocated to a PCB antenna, it is possible to implement a PCB antenna with the same or better performance than a chip antenna but at a much reduced cost.

#### 4.2.6 Baluns

Many of the above antennas mentioned are single-ended and designed to have a feed point impedance close to 50 Ohms. To interface these antennas to a balanced output/input, a device called a balun is required. The balun converts a single ended input to a balanced output together with an optional impedance transformation. The output is differential. That is, the output voltage on each pin is of equal magnitude, but off opposite phase. The output impedance is normally stated differential. That is, measured between

the two output pins. Because the balun is a discrete device, it is bidirectional. The balanced port can be both input or output.

Several discrete circuits are available that perform as baluns. Most of them are sensitive to input and output loading and PCB layout which requires cumbersome fine tuning. And all of these require at least two chip inductors. In the 2.4 GHz band, small ceramic baluns exist which are easy to use and are less sensitive to the PCB layout. Standard output impedances are 50, 100 and 200 Ohms.

The cost of a discrete balun is comparable to, or higher than, the ceramic balun, and the ceramic balun requires less board space. Therefore, the ceramic balun is recommended for most designs.

To interface with the MC13192/92/93, the standard component 50–200 Ohm balun is recommended. A 50–400 Ohm device provides slightly better performance, but it is not an off-the-shelf device.

## 5 Miniaturization Trade-offs

As previously stated, reducing antenna size results in reduced performance. Some of the parameters that suffer are:

- Reduced efficiency (or gain)
- Shorter range
- Smaller useful bandwidth
- More critical tuning
- Increased sensitivity to component and PCB spread
- Increased sensitivity to external factors

As stated, several performance factors deteriorate with miniaturization, but some antenna types tolerate miniaturization better than others. How much a given antenna can be reduced in size depends on the actual requirements for range, bandwidth, and repeatability. In general, an antenna can be reduced to half its natural size without much impact on performance. However, after a one half reduction, performance gets progressively worse as the radiation resistance drops off rapidly. As a rule, one half the antenna size equals one quarter the radiation resistance. As loading and antenna losses often increase with reduced size, it is clear that efficiency drops off quite rapidly.

The amount of loss that can be tolerated depends on the range requirements. Bandwidth also decreases, which causes additional mismatch losses at the band ends. The bandwidth can be increased by resistive loading, but this often introduces even more loss than the mismatch loss. The low bandwidth combined with heavy loading requires a spread analysis to ensure adequate performance with variations in component values and PCB parameters. As shown by these facts, it is often better not to reduce antenna size too much, if board space allows. Even if range requirements do not require optimum antenna performance, production problems and spread are minimized. It is also best to keep some clearance between the antenna and nearby objects. Although the antenna may be retuned to compensate for the loading introduced by the surroundings, tuning becomes more critical, and the radiation pattern can be heavily distorted.

## 6 Potential Issues

Numerous things can go wrong with an antenna design. The following list provides a few do's and don't's which may serve as a good checklist in a final design. Many of these items seem obvious to the experienced antenna designer, but many of these issues are routinely encountered in practice. This is obviously not a complete list.

- Never place ground plane or tracks underneath the antenna
- Never place the antenna very close to metallic objects
- Be careful about the wiring in the finalized product, not too close to the antenna
- A monopole antenna should have a reasonable ground plane to be efficient
- Do the final tuning in the end product, not in free air
- Never install a chip antenna in a vastly different layout than the reference design, and expect it to work without tuning
- Do not use a metallic enclosure or metallized plastic for the antenna
- Test the plastic casing for high RF losses, preferably before production
- Never do a cut and paste antenna design and expect it to work without testing
- Never use low-Q loading components, or change manufacturer without retesting
- Do not use very thin PCB tracks, the tracks should be fairly wide

## 7 Recommended Antenna Designs

Two antenna designs are employed for the MC13192/93 hardware.

1. Dipole (lowest cost implementation)
2. F-antenna

However, most antenna designs are intended to interface with the usual 50 Ohm industrial standard. This is certainly true for all chip antennas. For interfacing the MC13191/92/93 to a single-ended 50 Ohm antenna, it has been shown that the smallest and most cost-effective solution are two ceramic baluns and an RX/TX switch.

The MC13192-EVB, which is included in the MC13193EVB-A00, provides an example of this setup. Users can omit the RX/TX switch and add two chip antennas, but in most cases the switch is less costly than another antenna. Any other 50 Ohm, single ended antenna design can be added if required. This includes among others the F-antenna, monopole, helical, and the usual commercially available chip antennas. The single-port, 50 Ohm solution has the added advantage that by adding a ceramic bandpass filter for improved performance is easy. For a very low cost, low bill of materials (BOM) count solution, users should consider interfacing the antenna(s) directly to MC13191/92/93, and integrate both antennas and matching components into the PCB.

This setup does have some unique requirements, due to the input/output requirements of the MC13191/92/93. To achieve a good match to the MC13192/92/93, the antenna should include the following properties:

- Balanced design

- Feedpoint impedance of 2-300 Ohm
- Easily loaded to smaller size, with PCB or lumped loading
- Provide a DC feed to the TX port
- Easy to implement in FR-4 PCB

Of the different antenna types, the following are especially suited to interface with the MC13191/MC13192:

- Dipoles with gamma match, or folded dipoles
- Half or quarter wave loops
- The slot antenna may also prove useful in some cases

Because the MC13192/92/93 has separate RX and TX ports, two antennas will eliminate RX/TX switching. The two antennas should ideally be placed at least  $\frac{1}{4}$  wavelength apart to reduce coupling, but due to the low power requirements, closer spacing can be allowed. The following list shows the results from testing with dipole antennas and shows the typical isolation. The values are empirical, and depend somewhat on the surrounding layout etc., but they should provide a reasonable indication of the isolation obtainable.

- On each side of a PCB, on top of each other: – 3 to – 4 dB
- Very close, on the same side of the PCB: – 6 dB
- 15 mm apart: – 10 dB
- 25 mm apart: – 13 dB

For the MC13192/92/93 to show optimum performance, at least 6 dB of TX to RX isolation is required or the ESD protection diodes in the RX input cause some TX power loss and perhaps also increased 3rd harmonic output. However, placing the RX and TX dipoles on top of each other, with only 3 dB of isolation results in the smallest design possible, and only reduces TX power a few dB, which is entirely acceptable in most cases. The RX side works well with any isolation available. When the antennas are very close, the coupling results in some interaction in the tuning of the two antennas. With just a few attempts, users should be able to optimize performance.

## 8 Design Examples

The following section shows a series of design examples. Each of these has been tuned for a particular design, so a cut-and-paste approach will not necessarily ensure optimum performance. However, these designs are a good starting point for further optimization, and they indicate the approximate size of the particular antenna.

### 8.1 F-antennas

F-Antennas 2 and 3 have some of the FR-4 material cut away, to improve efficiency. F- Antenna 3 has been designed for some loading by a plastic casing.

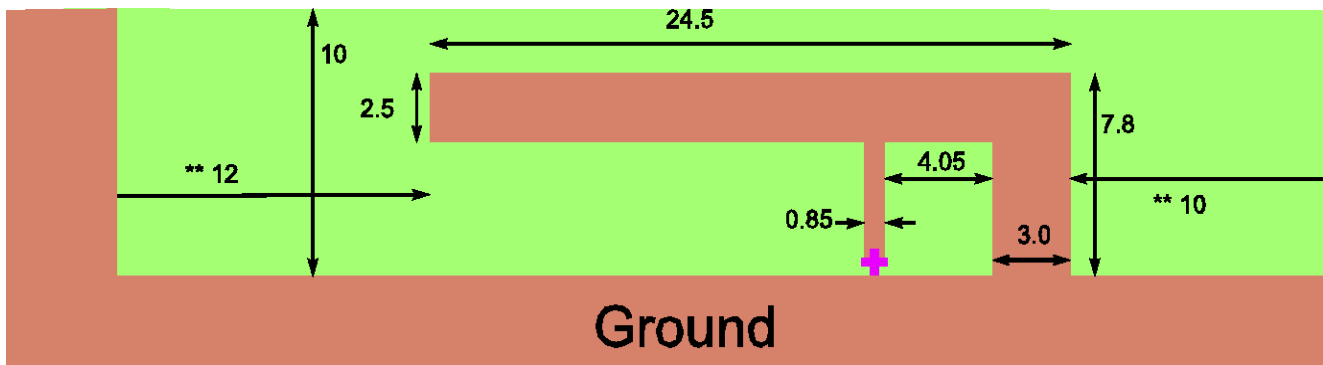

Figure 11. F Antenna 1

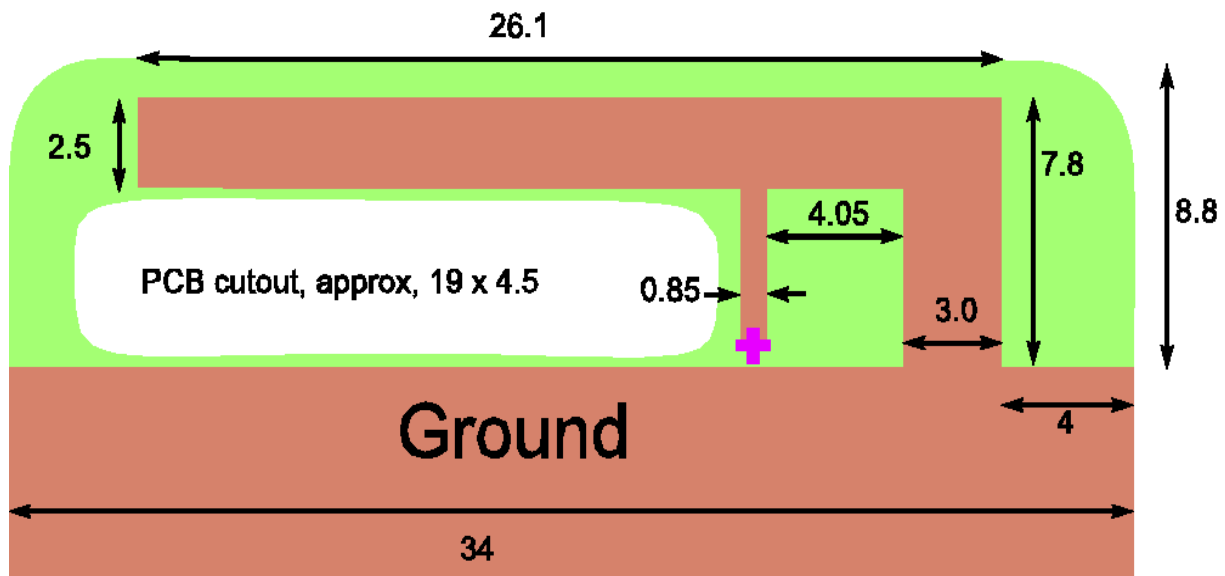

Figure 12. F Antenna 2



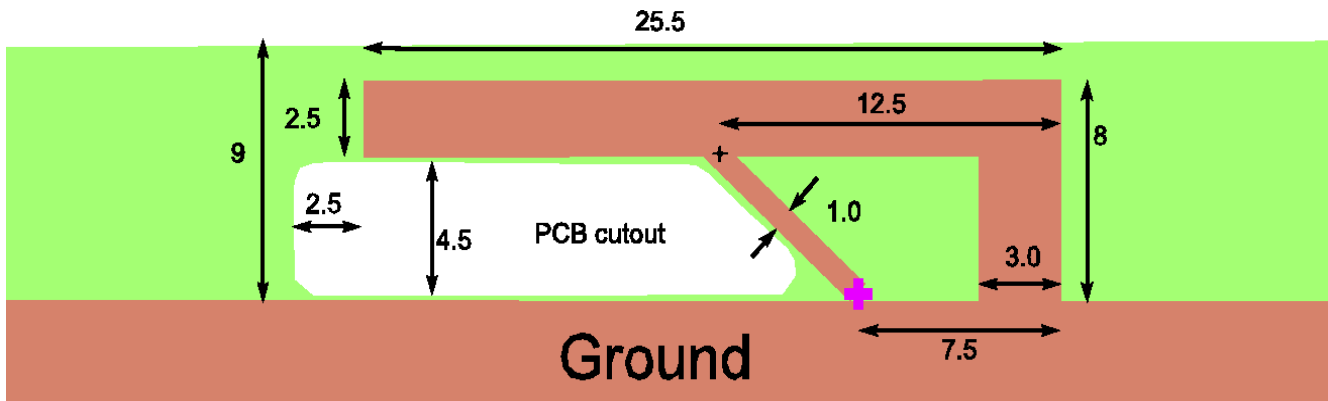

Figure 13. F Antenna 3

**EVK Horizontal PCB Radiation Pattern**

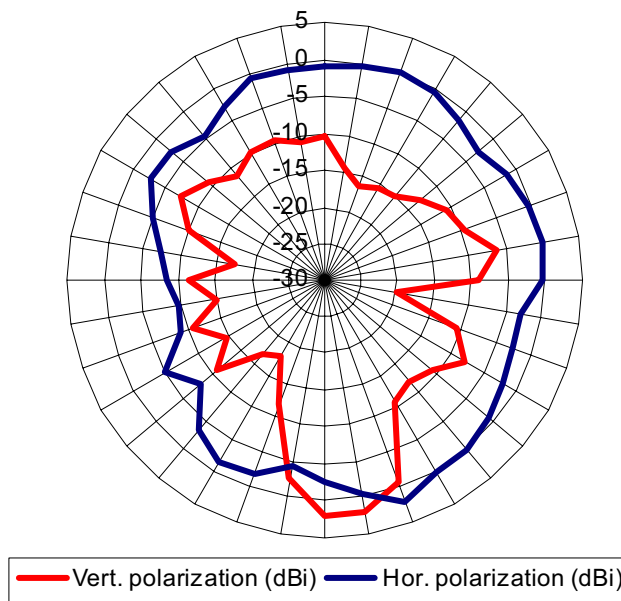
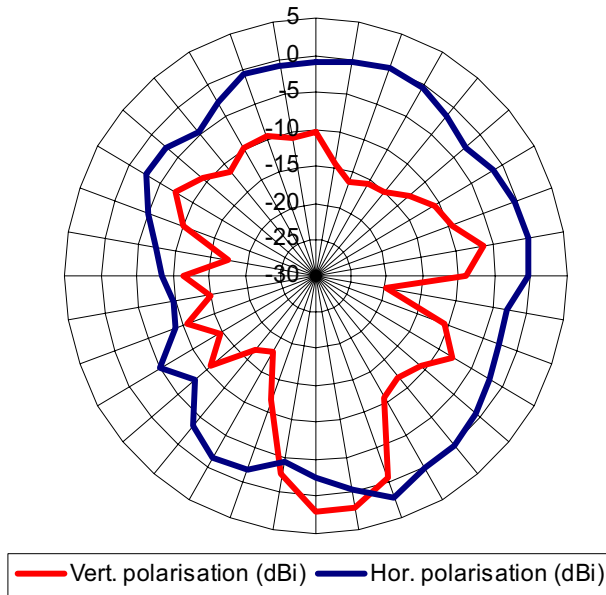

Figure 14. F-Antenna Radiation Pattern (For Antennas as Shown in Figures 11 and 12)

### EVK Horizontal PCB Radiation Pattern



**Figure 15. F-Antenna Radiation Pattern (Rotated 90 Degrees For Antennas as Shown in Figures 11 and 12)**

The following figure shows a typical plot of the return loss and bandwidth obtainable with an F-antenna. A slight ripple is caused by the ground plane size.

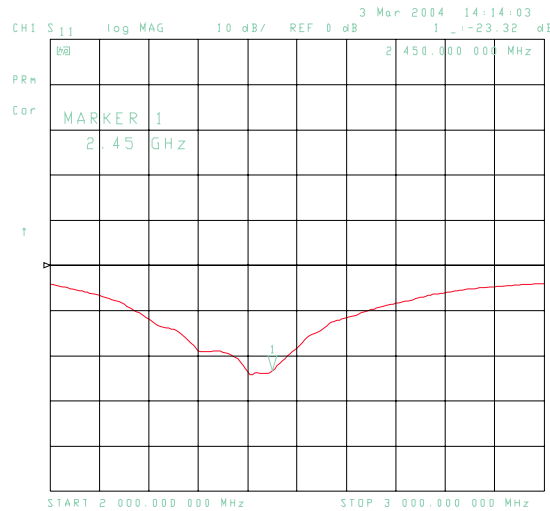

**Figure 16. F Antenna Return Loss and Bandwidth**

## 8.2 Chip Antennas

Numerous chip antenna designs exist. It is recommended to carefully follow the manufacturers recommendations regarding ground, keep-out areas, etc. Only one example is shown, indicating that some tuning will be necessary. The chip antenna, AT9520-B2R4HAAT from ACX, has been mounted on the board as shown in the following figure.

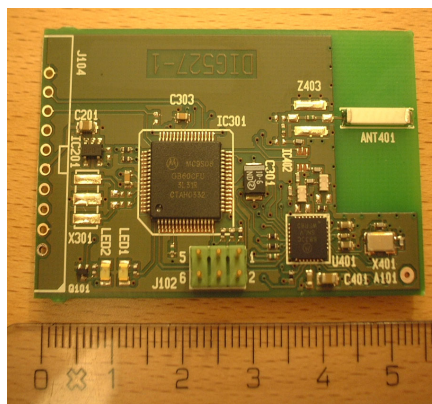

**Figure 17. Chip Antenna**

### NOTE

The chip antenna, which is the helix-type, has been mounted perpendicular to the ground plane and there is considerable clearance around the antenna. Both factors ensure good efficiency.

Without any tuning, the antenna has a resonant frequency at 2.85 GHz and the return loss at 2.45 GHz is very bad (about  $-2$  dB). The antenna can be tuned either by inserting a chip coil in series with the feed point, or adding a PCB track to the opposite end to lower the resonant frequency to 2.45 GHz. It turned out that a tuning coil of 5.6 nH or a PCB track of 6 mm was optimal.

## 8.3 Dipole Antennas

Two full-size designs have been tested.

1. A printed balun and 50 ohm connector for use with the RF Daughter Card, 13192RFC-A00.
2. A printed balun on the MC13192-SARD which is included in the 13192DSK-A00, (Developer's Starter Kit).

The shape assures a reasonable omnidirectional coverage while feeding and matching is done by a hairpin design. In one particular design, separate TX and RX antennas were placed on top of each other, one on each side of the PCB. Performance in this design has been adequate. This dipole has also been bent to improve the omnidirectional characteristics. Impedance match to 200 Ohms is improved by using a folded design, with uneven track within the antenna. Gerber data is available for both antennas.

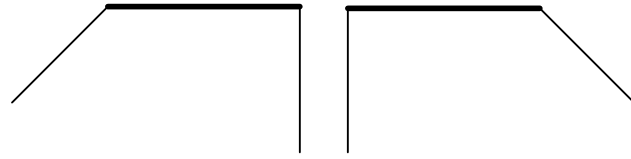

Total Length = 55 mm (Tip-to-Tip)  
Center part = 30 mm (Length)  
Track = 2.5 mm  
Bending angle = 45 degrees

Figure 18. Single Bend Dipole

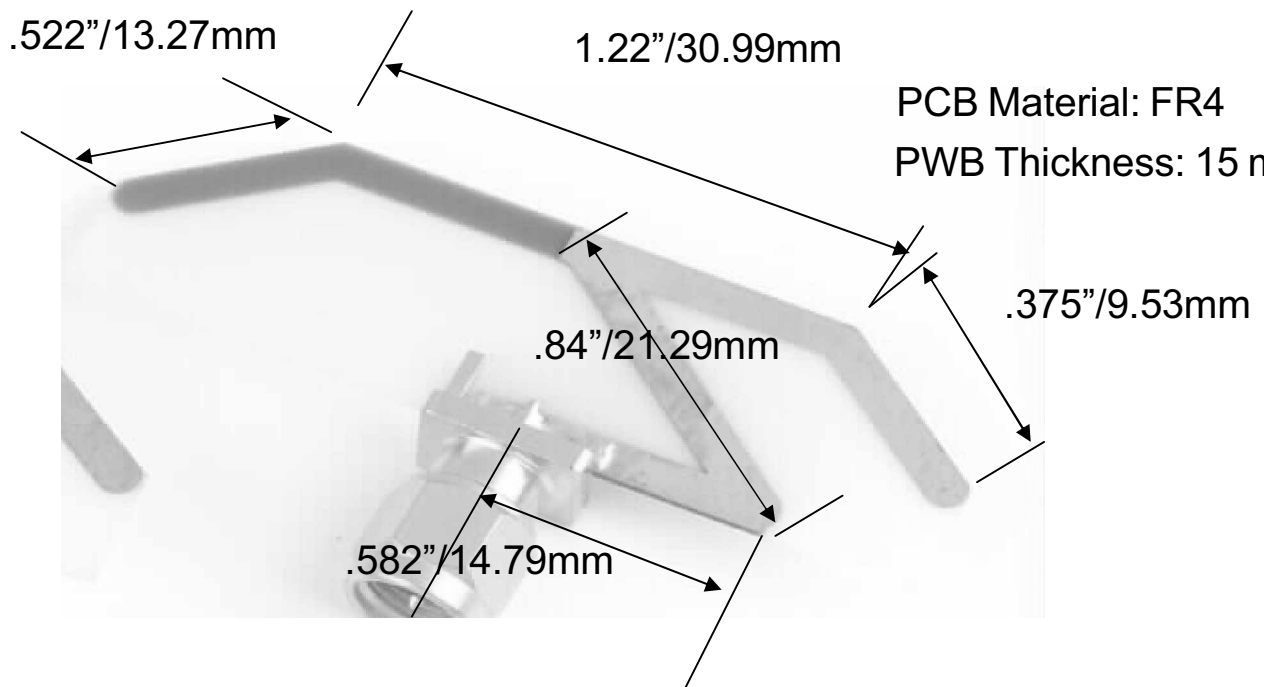

Figure 19. Dipole Antenna With Dimensions

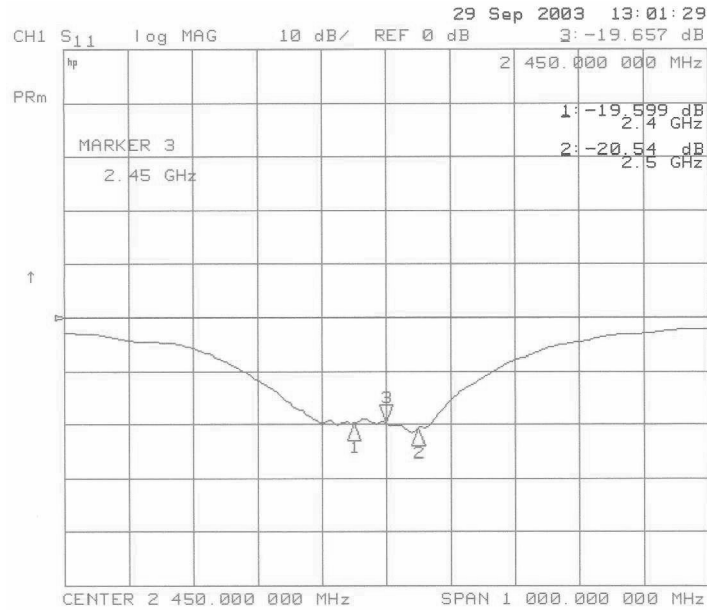

Figure 20. VSWR Plot of Dipole Antenna

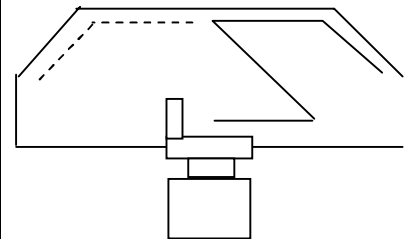
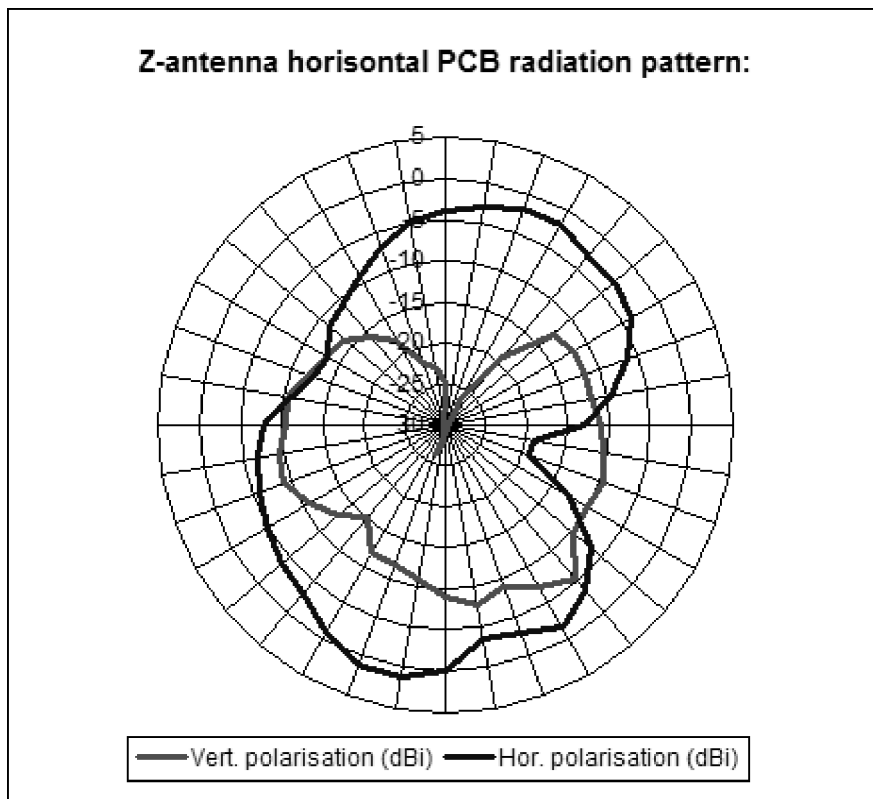

Figure 21. Antenna Pattern for Dipole Antenna in Position Shown (1 of 3)

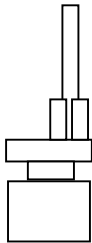
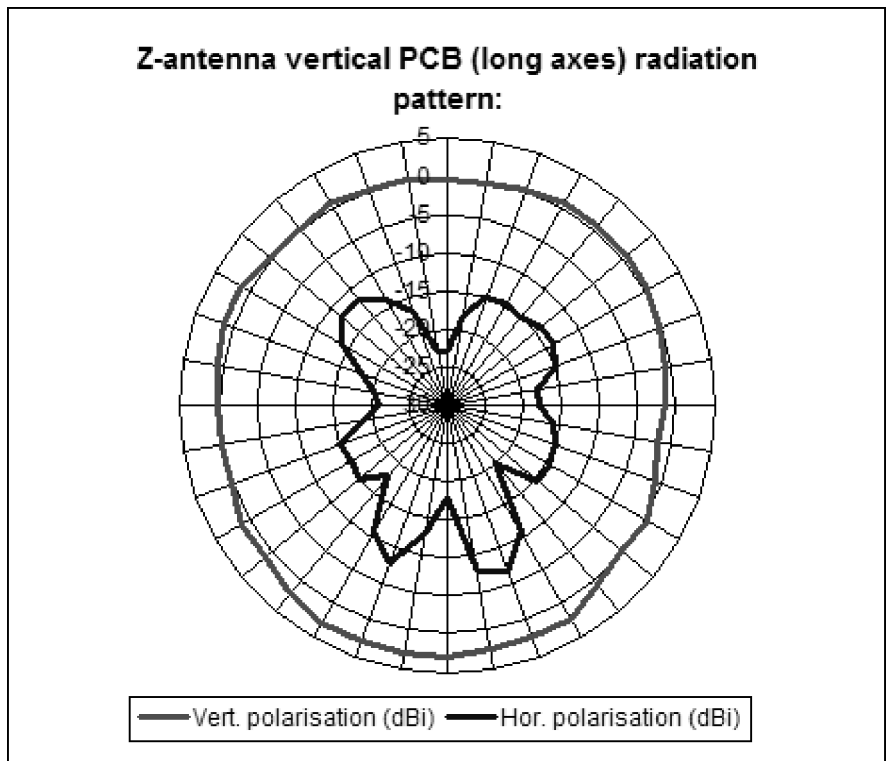
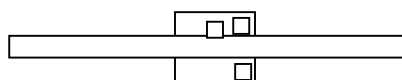
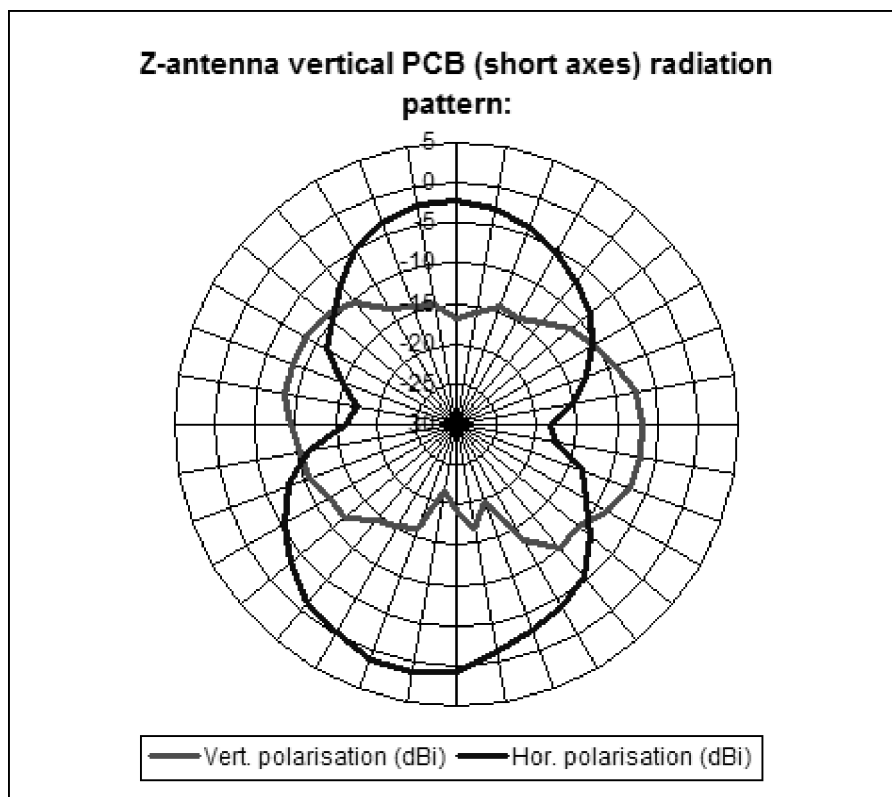

Figure 22. Antenna Pattern for Dipole Antenna in Position Shown (2 of 3)



**Figure 23. Antenna Pattern for Dipole Antenna in Position Shown (3 of 3)**

## 8.4 Loop Antennas

An experimental full-wave loop, loaded with chip inductors, is shown in the following figure. Gain is about  $-3$  dBm, which is much better than a chip antenna of comparable performance.

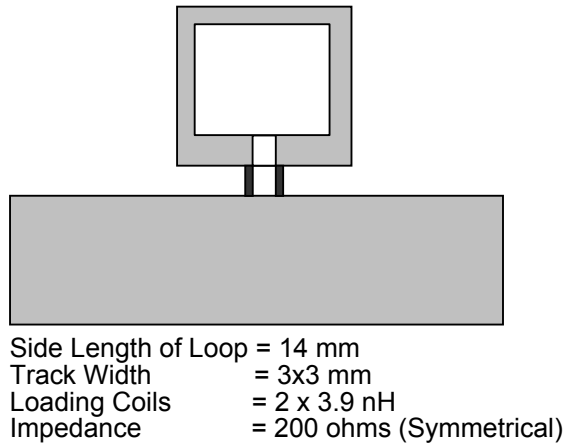

**Figure 24. Experimental Full Wave Loop**

## 8.5 Slot Antenna

An experimental quarter-wave slot antenna was tested with the outline as shown in the following figure. The antenna was built using a Pertinax PCB, which is not recommended due to high losses. The antenna still performed reasonably well. A design using FR-4 and a milled slot is recommended.

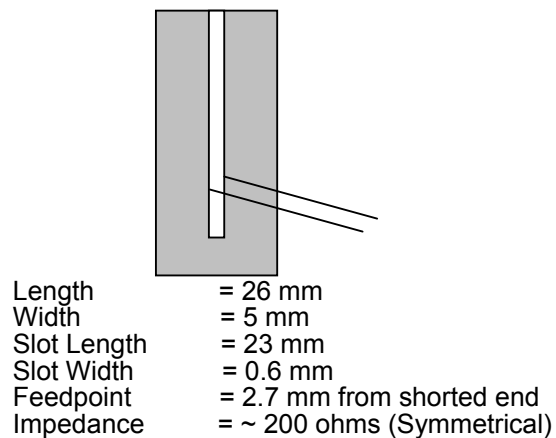

**Figure 25. Experimental Quarter-wave Slot**



## 8.6 Patch Antenna

Two patch antennas, originally designed as diversity antennas, are shown in the following figures. The types have no ground beneath them, and have fairly high bandwidths. Other types, which sit on top of a ground plane, can be made considerably smaller, but the bandwidth is often less than required.

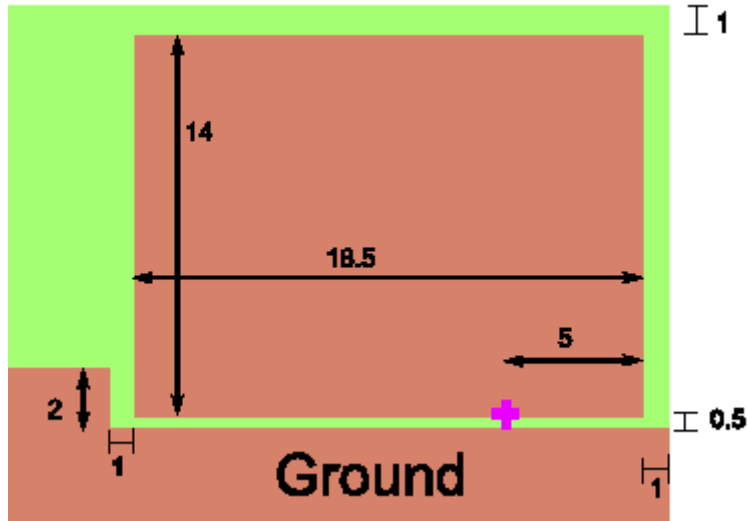

Figure 26. Patch Antenna 1

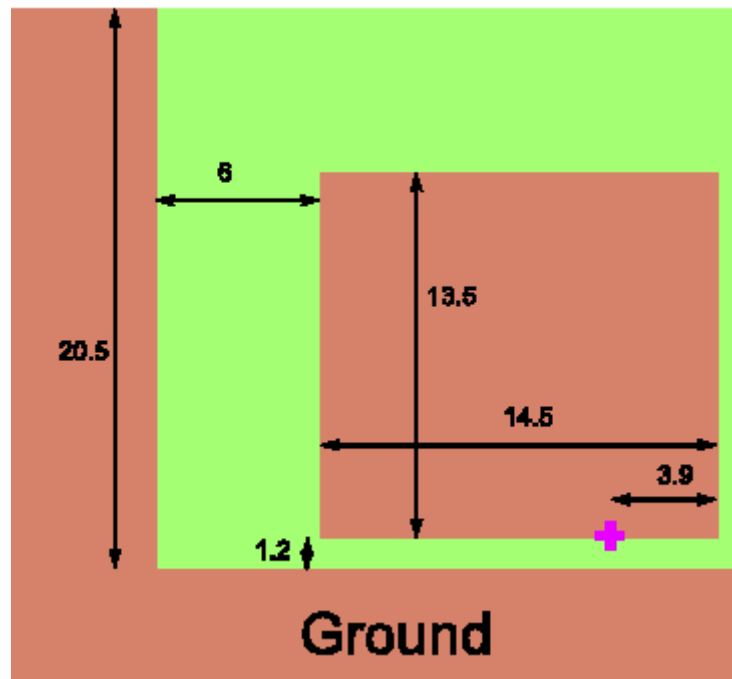

Figure 27. Patch Antenna 2

**How to Reach Us:**

**USA/Europe/Locations Not Listed:**

Freescale Semiconductor Literature Distribution  
Center  
P.O. Box 5405  
Denver, Colorado 80217  
1-800-521-6274 or 480-768-2130

**Japan:**

Freescale Semiconductor Japan Ltd.  
Technical Information Center  
3-20-1, Minami-Azabu, Minato-ku  
Tokyo 106-8573, Japan  
81-3-3440-3569

**Asia/Pacific:**

Freescale Semiconductor Hong Kong Ltd.  
2 Dai King Street  
Tai Po Industrial Estate  
Tai Po, N.T., Hong Kong  
852-26668334

**Home Page:**

<http://Freescale.com>

Information in this document is provided solely to enable system and software implementers to use Freescale Semiconductor products. There are no express or implied copyright licenses granted hereunder to design or fabricate any integrated circuits or integrated circuits based on the information in this document.

Freescale Semiconductor reserves the right to make changes without further notice to any products herein. Freescale Semiconductor makes no warranty, representation or guarantee regarding the suitability of its products for any particular purpose, nor does Freescale Semiconductor assume any liability arising out of the application or use of any product or circuit, and specifically disclaims any and all liability, including without limitation consequential or incidental damages. "Typical" parameters that may be provided in Freescale Semiconductor data sheets and/or specifications can and do vary in different applications and actual performance may vary over time. All operating parameters, including "Typicals", must be validated for each customer application by customer's technical experts. Freescale Semiconductor does not convey any license under its patent rights nor the rights of others. Freescale Semiconductor products are not designed, intended, or authorized for use as components in systems intended for surgical implant into the body, or other applications intended to support or sustain life, or for any other application in which the failure of the Freescale Semiconductor product could create a situation where personal injury or death may occur. Should Buyer purchase or use Freescale Semiconductor products for any such unintended or unauthorized application, Buyer shall indemnify and hold Freescale Semiconductor and its officers, employees, subsidiaries, affiliates, and distributors harmless against all claims, costs, damages, and expenses, and reasonable attorney fees arising out of, directly or indirectly, any claim of personal injury or death associated with such unintended or unauthorized use, even if such claim alleges that Freescale Semiconductor was negligent regarding the design or manufacture of the part.

Freescale™ and the Freescale logo are trademarks of Freescale Semiconductor, Inc. All other product or service names are the property of their respective owners.

© Freescale Semiconductor, Inc. 2004.