

电源 & 上电复位

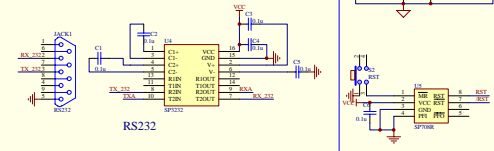

RS232

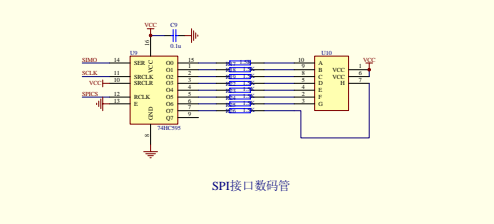

SPI接口数码管

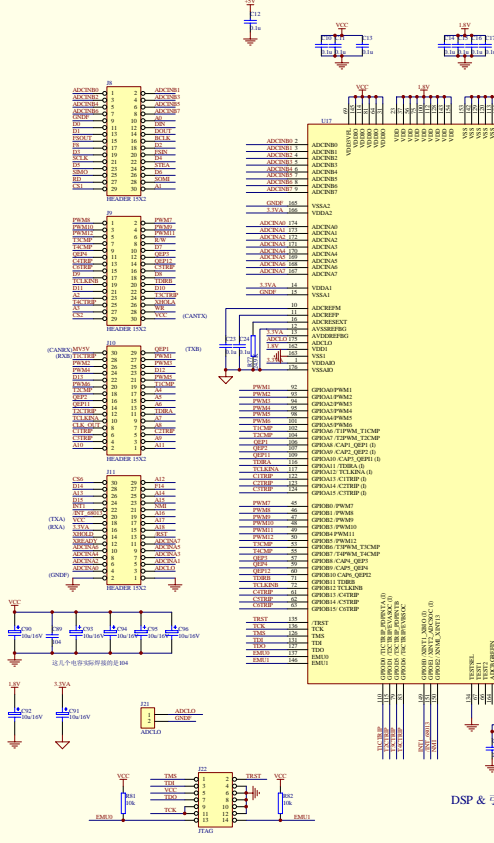

DSP & 引出管脚

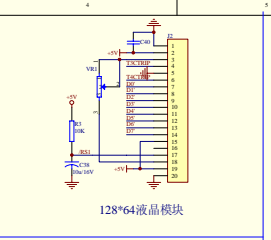

128*64液晶模块

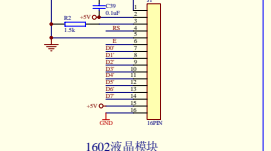

1602液晶模块

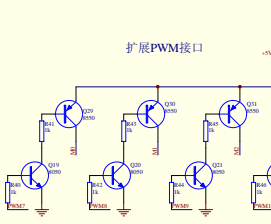

扩展PWM接口

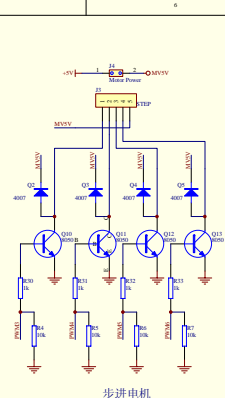

步进电机

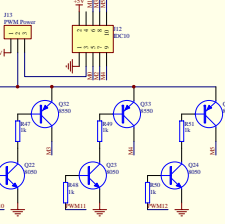

直流电机

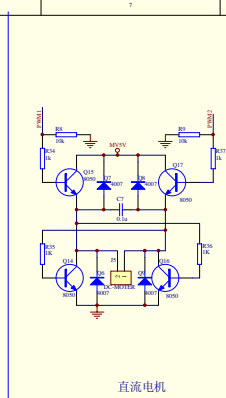

IIC & EEPROM

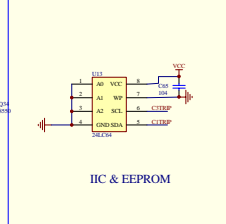

RAM & FLASH

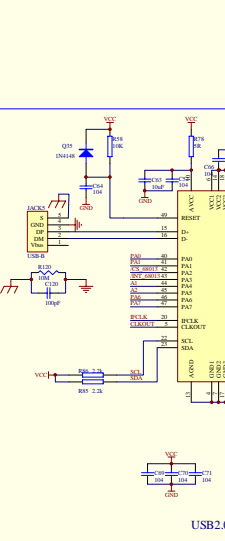
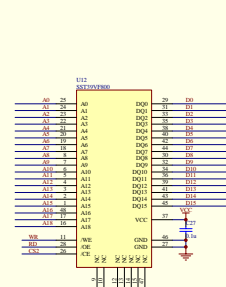
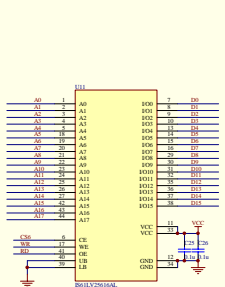

USB2.0从机

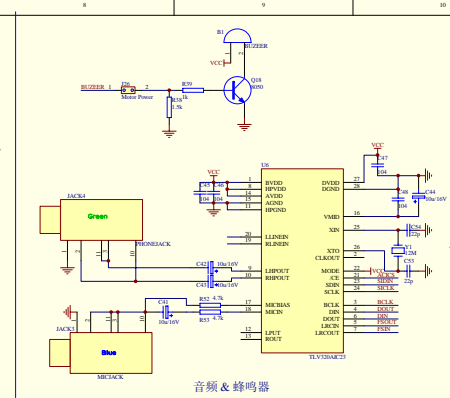

音频 & 扬声器

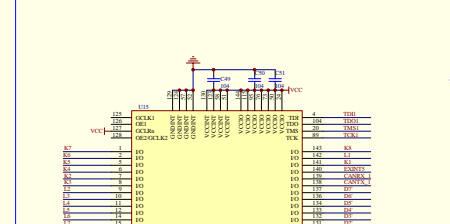

RS485

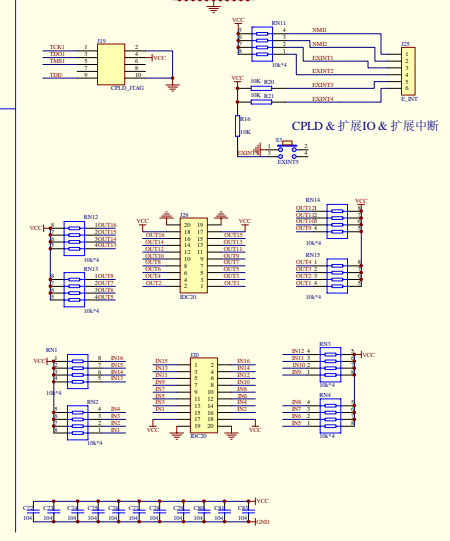
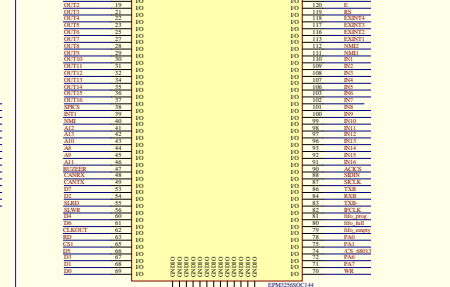

CPLD & 扩展IO & 扩展中断

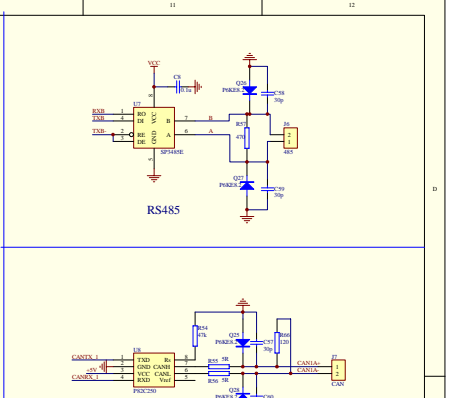

CAN总线

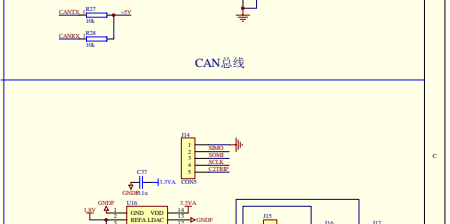

A/D & D/A

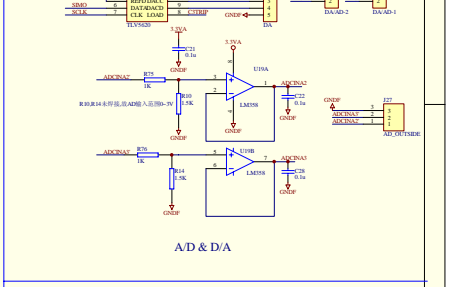

按键 & LED指示灯

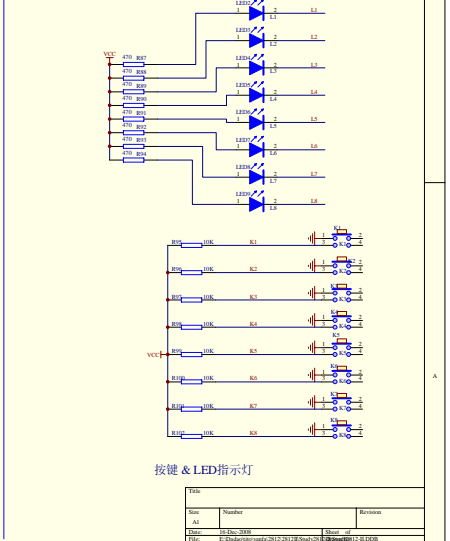

Pin	Number	Screen
Pin 1	1	Screen 1
Pin 2	2	Screen 2
Pin 3	3	Screen 3
Pin 4	4	Screen 4
Pin 5	5	Screen 5
Pin 6	6	Screen 6
Pin 7	7	Screen 7
Pin 8	8	Screen 8
Pin 9	9	Screen 9
Pin 10	10	Screen 10
Pin 11	11	Screen 11
Pin 12	12	Screen 12