

具体功能请参考相关芯片资料  
原理图只提供基本电气连接

### DY-mini80

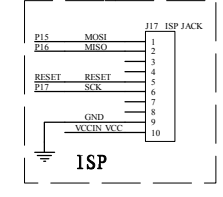
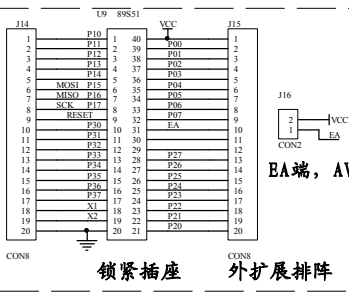
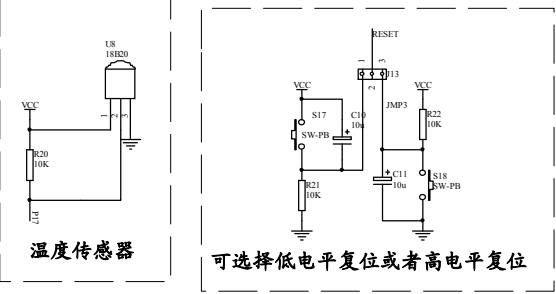
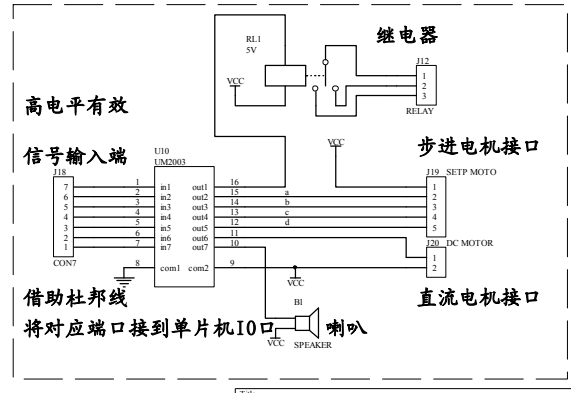
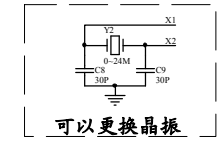
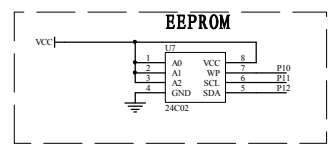
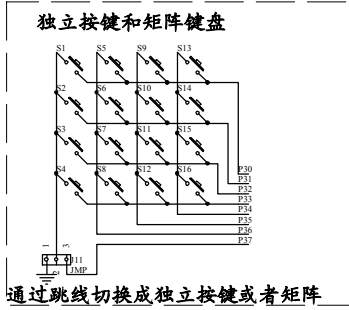
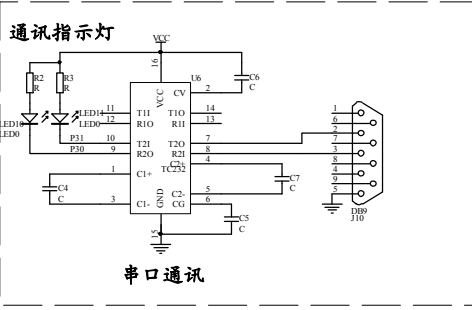
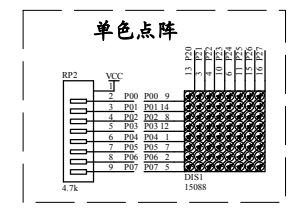
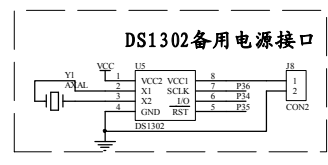
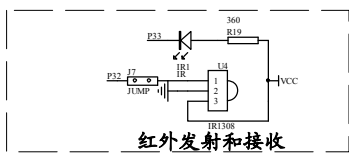

Title:	Number:	Revision:
Size:	2-125-2008	Sheet: of
Date:	F:\hw\avr\电路\mm51\mm80\13b	Drawn By: