

REVISION RECORD			
LTR	ECO NO:	APPROVED:	DATE:

D

D

C

C

B

B

A

A

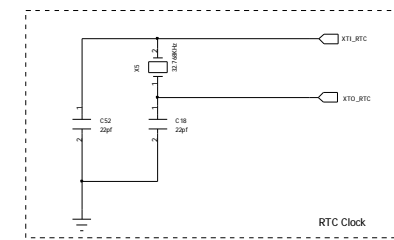
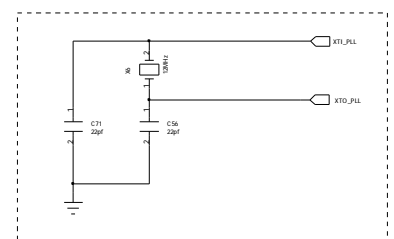
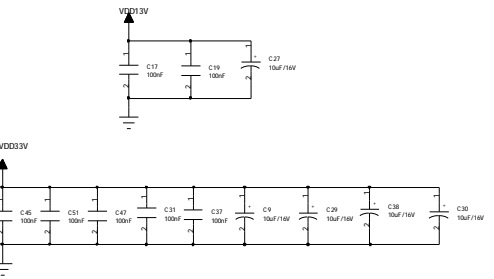
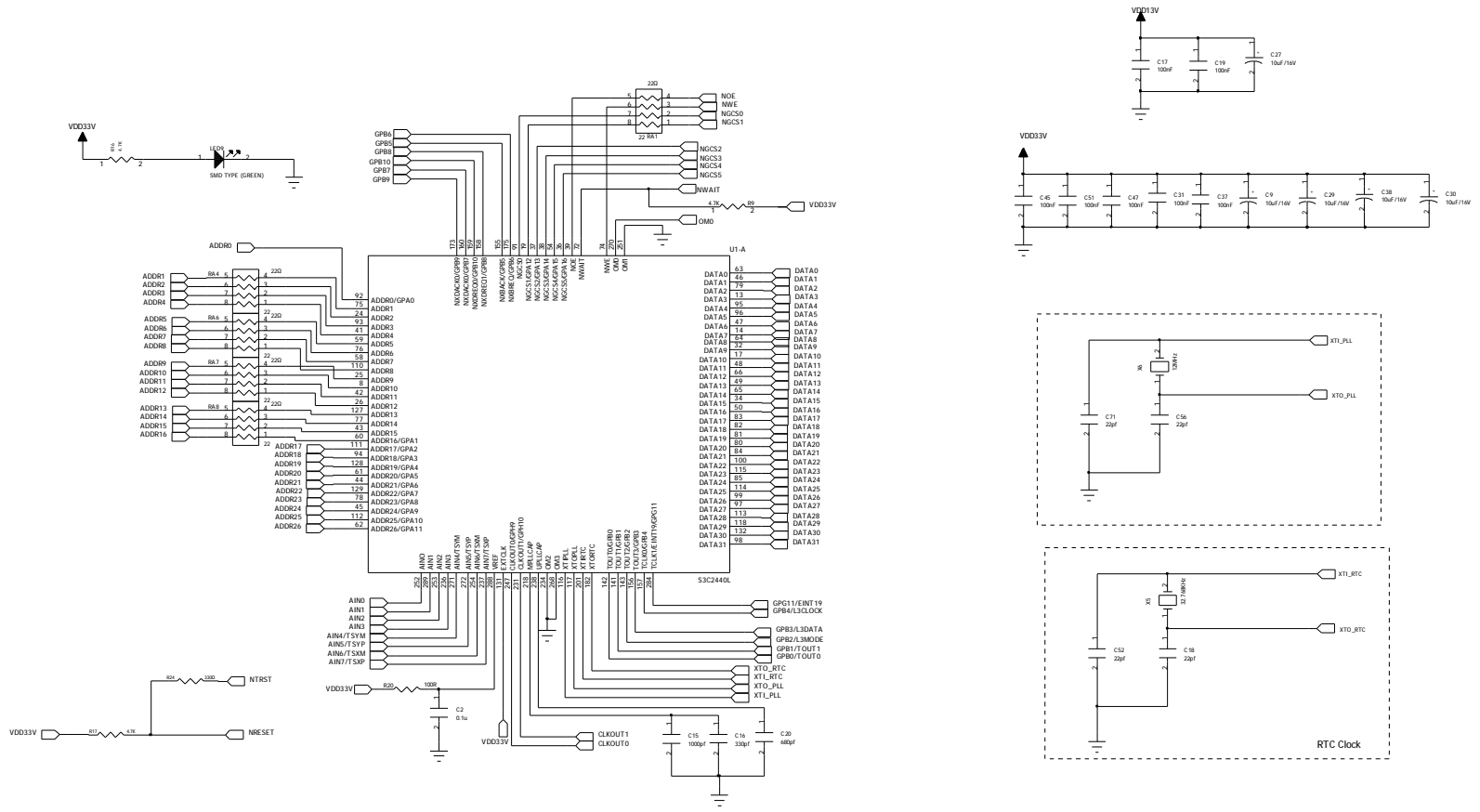

COMPANY: 保定飞凌嵌入式技术有限公司

TITLE: 2440核心板

DRAWN:	DATED:
CHECKED:	DATED:
QUALITY CONTROL:	DATED:
RELEASED:	DATED:

CODE:	SIZE:	DRAWING NO:	REV:
SCALE:			SHEET: 8/8

REVISION RECORD			
LTR	ECO NO.	APPROVED:	DATE:

Address Step	NAND Flash Configuration
J3 (NCON)	
0	512 Byte/Page , 3 Step Addressing
1	512 Byte/Page , 4 Step Addressing

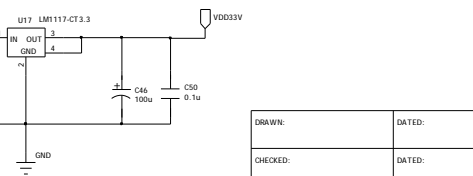
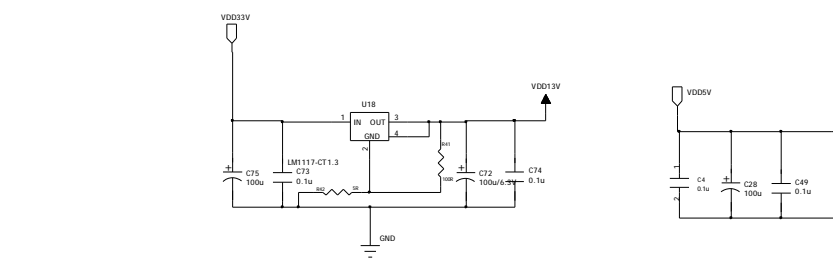
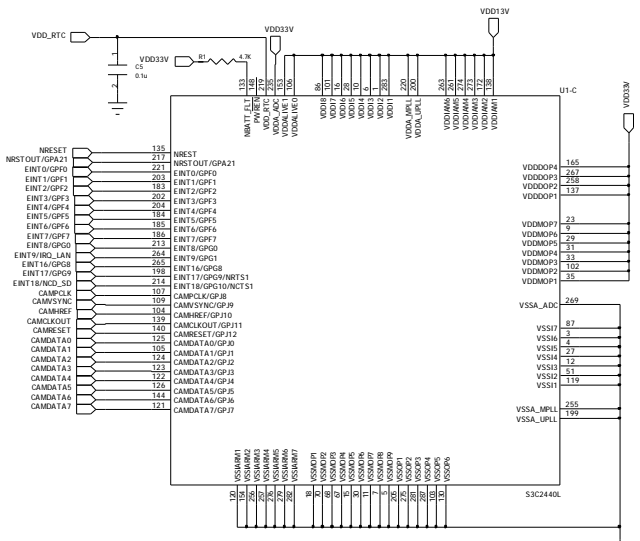
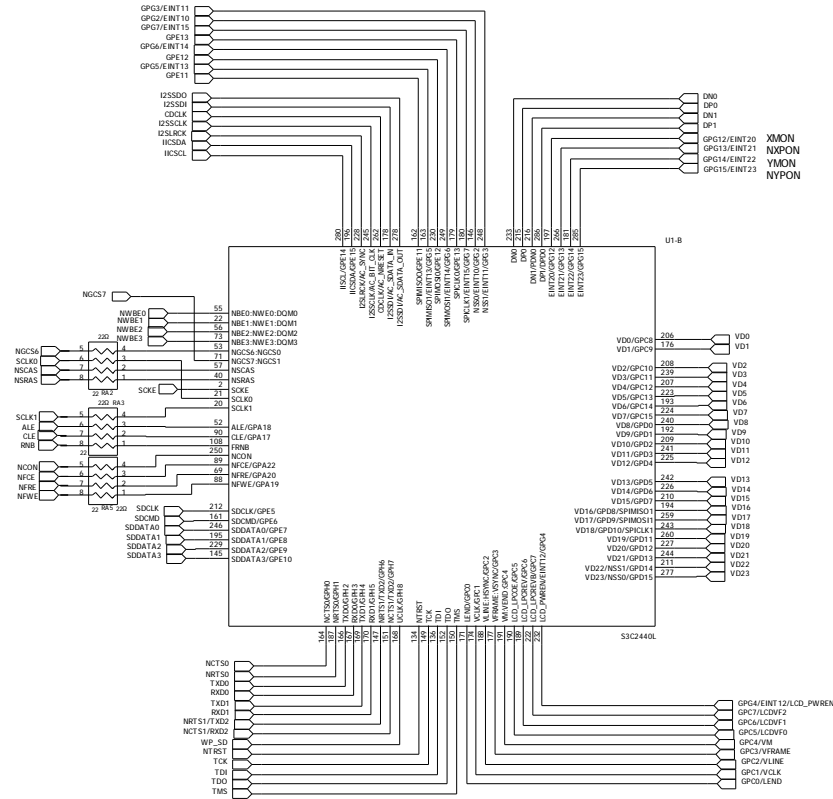
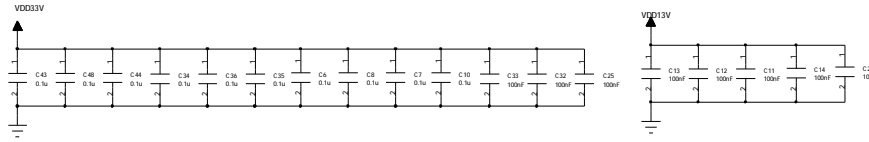

COMPANY: 保定飞凌嵌入式技术有限公司			
TITLE: 2440核心板			
CODE:	SIZE:	DRAWING NO.:	REV:
SCALE:			SHEET: OF

DRAWN:	DATED:
CHECKED:	DATED:
QUALITY CONTROL:	DATED:
RELEASED:	DATED:

REVISION RECORD			
LTR	ECO NO:	APPROVED:	DATE:

D

D

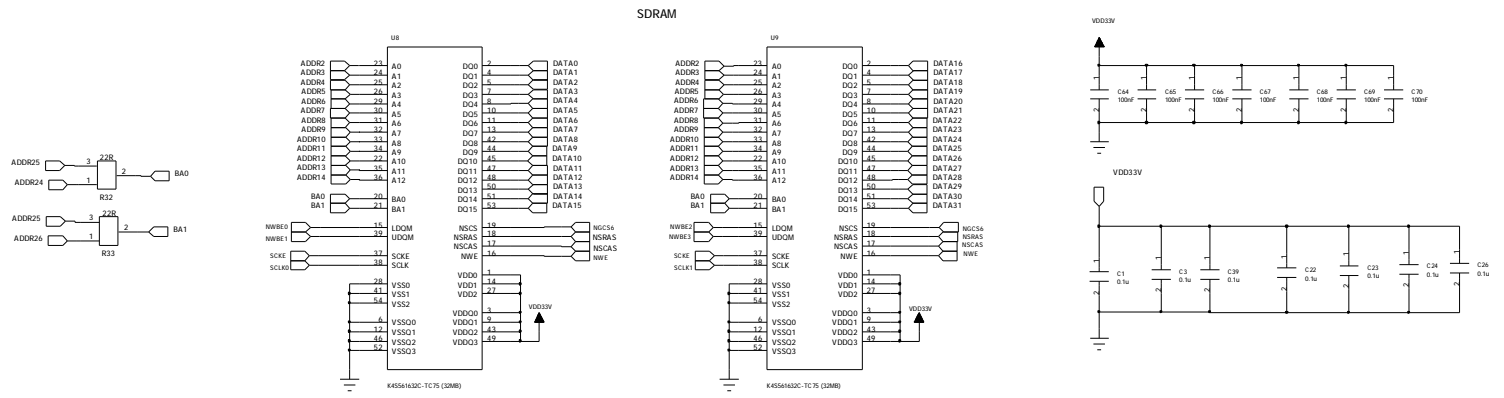

C

C

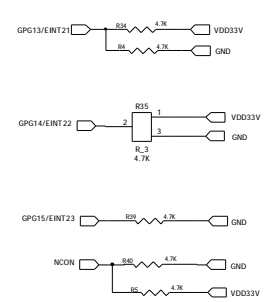

B

B

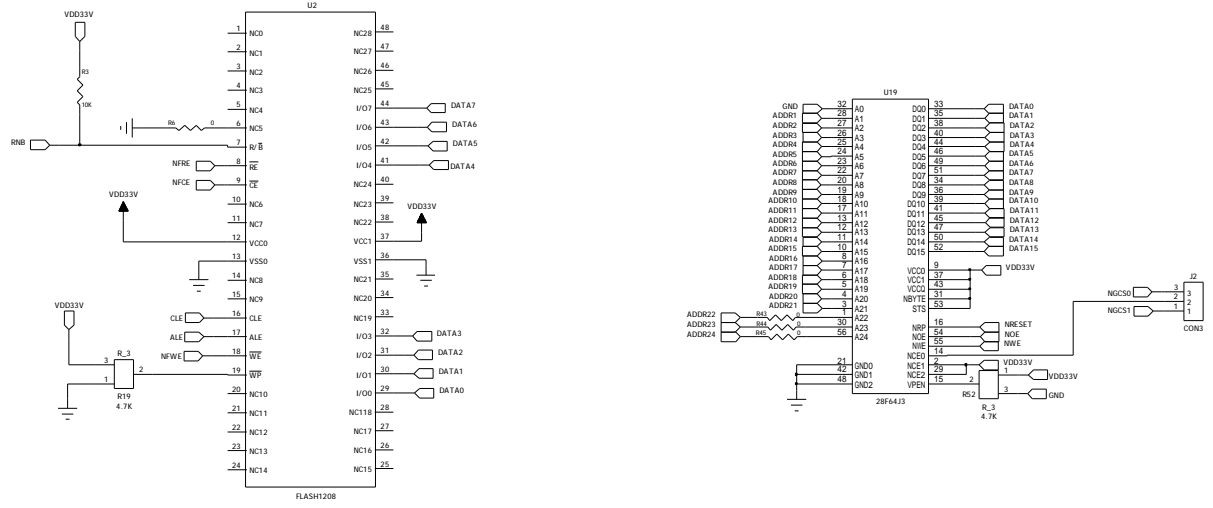

A

A

COMPANY: 保定飞凌嵌入式技术有限公司

TITLE: 2440核心板

DRAWN:	DATED:	CODE:	SIZE:	DRAWING NO.:	REV:
CHECKED:	DATED:				
QUALITY CONTROL:	DATED:				
RELEASED:	DATED:				

SCALE: SHEET: OF

REVISION RECORD			
LTR	ECO NO.	APPROVED:	DATE:

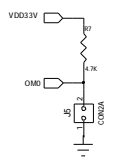
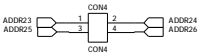
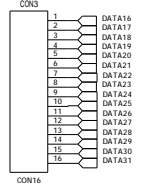
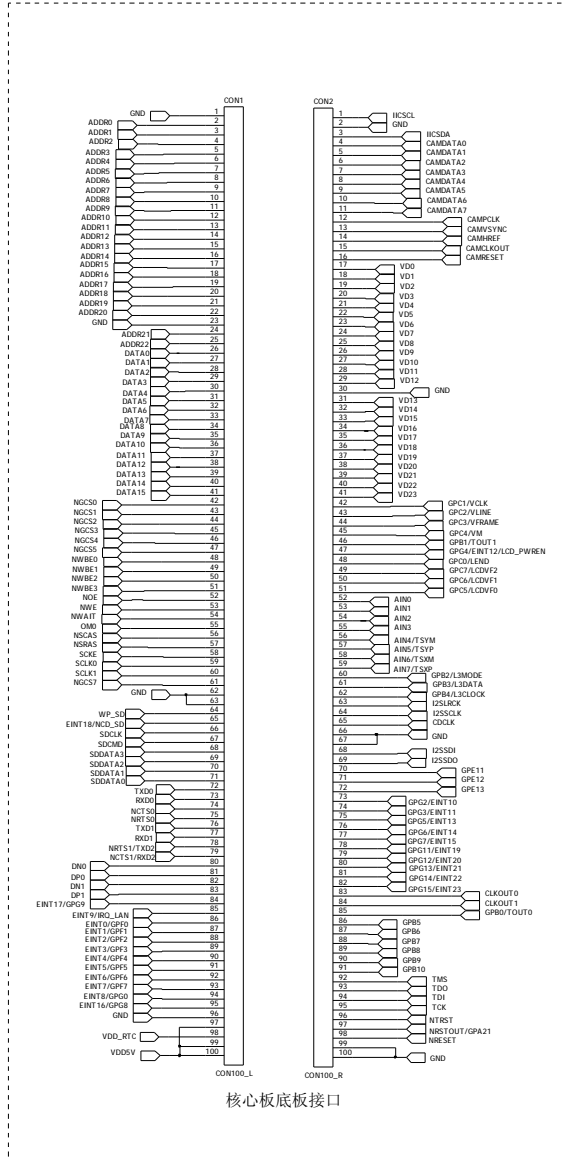

COMPANY: 保定飞凌嵌入式技术有限公司			
TITLE: 2440核心板			
DRAWN:	DATED:	CODE:	REV:
CHECKED:	DATED:	SIZE:	DRAWING NO.:
QUALITY CONTROL:	DATED:	SCALE:	SHEET: 4 of 4
RELEASED:	DATED:		