

Item	Value	Revision
Item	0000	
Rev	Number	Revision
AI		
Date	2008.2.7	Shen
内部文件, 仅供内部使用		

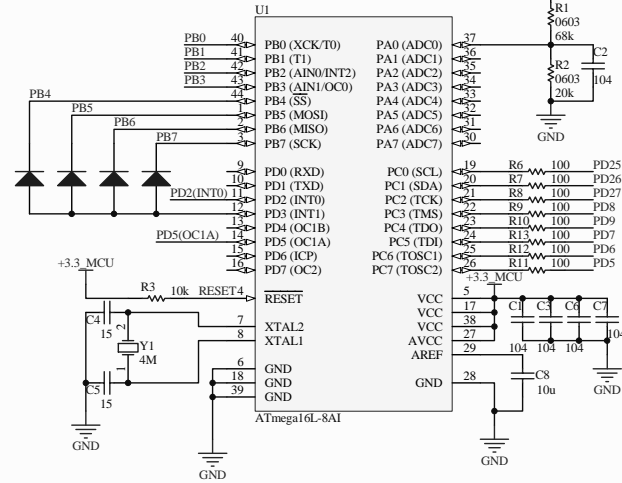

Title		
lcd_key		
Size	Number	Revision
A3		
Date:	2010-2-7	Sheet of
File:	E:\新版正式版示波器工程\lcd_key_pov\lcd_key.dwg	

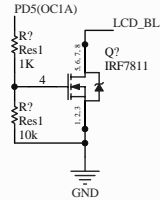
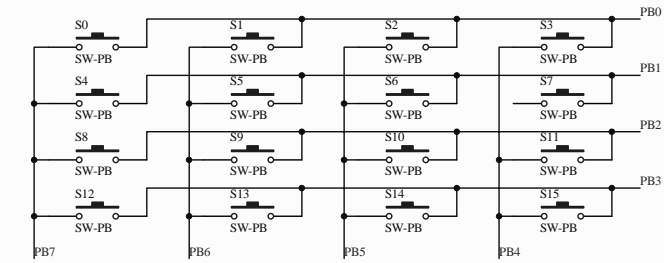
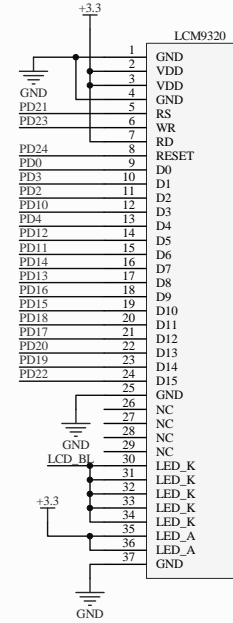
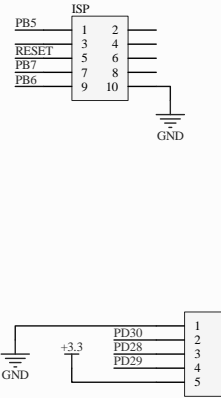
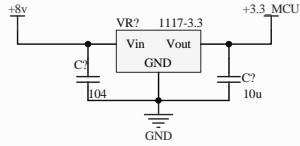
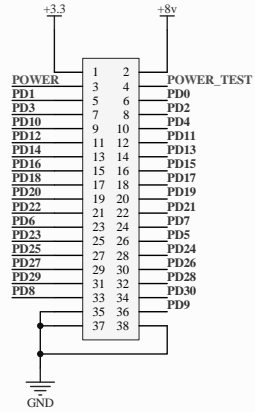