

Power Module

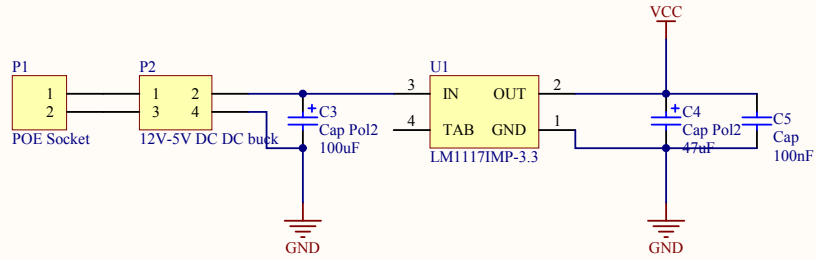

Clock

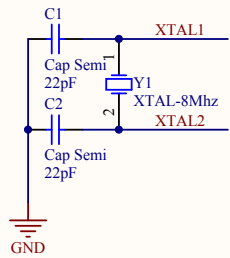

LEDs

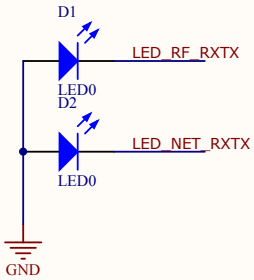

Reset Module

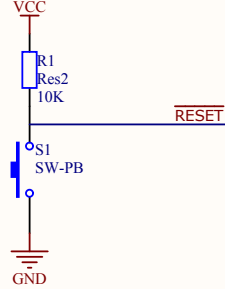

Tr24 Wireless Module

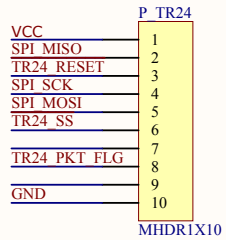

MCU

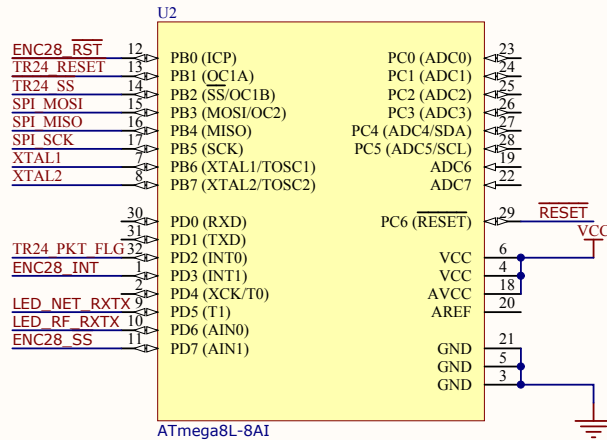

ENC28J60 Ethernet Module

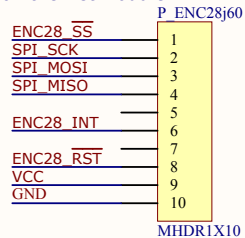

Title		
IHES Etherbridge		
Size	Number	Revision
A4		
Date:	2010/2/20	Sheet of
File:	C:\eskssoft\etherbridge.SchDoc	Drawn By: Shikai Chen