

REVNO A/0	REVISION NOTE RELEASED	DATE	DRAW	CHECK
--------------	---------------------------	------	------	-------

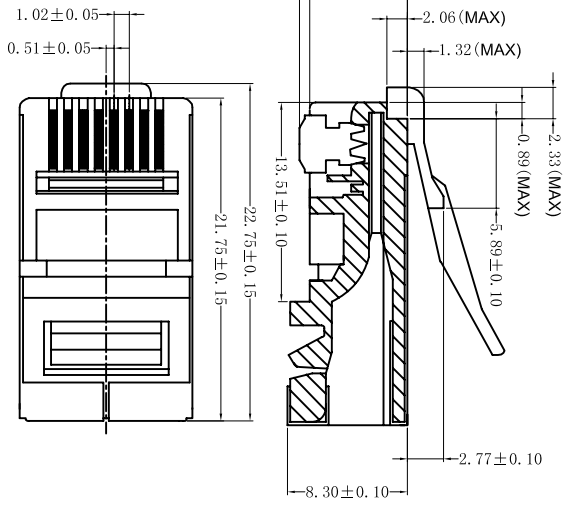
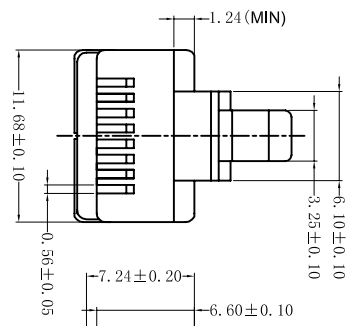
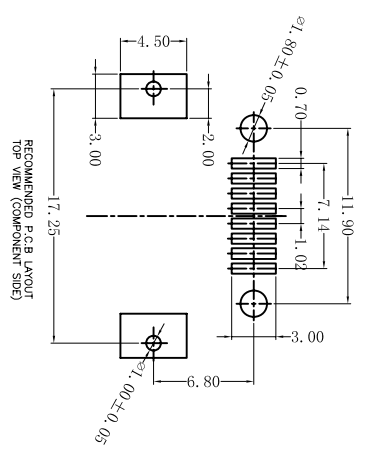
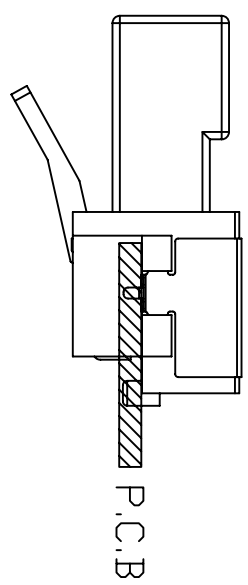
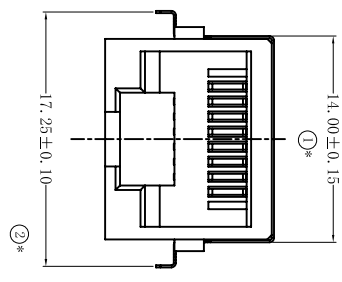
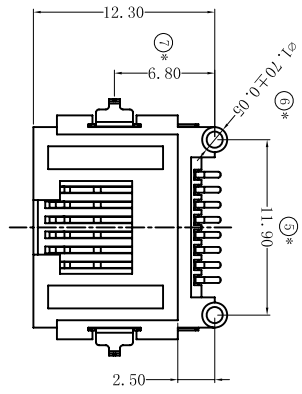
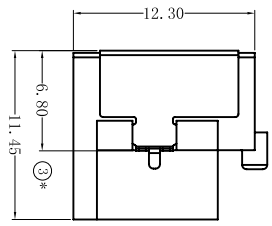
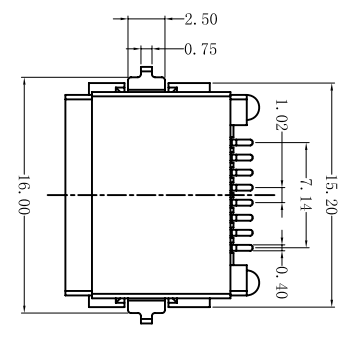
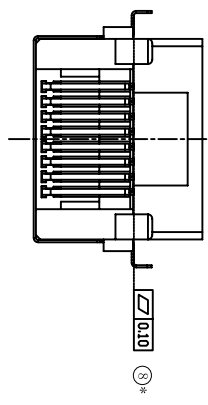

1. MATERIALS
 - INSULATOR: LCP COLOR BLACK U194V-0.
 - SHIELD: PHOSPHOR BRONZE, PLATING SEE P/N.
 - CONTACT: PHOSPHOR BRONZE, GOLD PLATED ON CONTACT AREA AND BRIGHT TIN OR Au PLATED ON SOLDER AREA

2. ELECTRICAL
 - INSULATION RESISTANCE: 100 MW MIN.
 - DIELECTRIC WITHSTANDING VOLTAGE: 500 VAC (R.M.S.)
 - CONTACT RESISTANCE: 30 mΩ MAX.

3. ENVIRONMENTAL
 - TEMPERATURE RANGE: -55°C TO +85°C
4. ROHS COMPLIANT, ALL MATERIALS AND PROCESS.

DIMENSION UNIT MM	PRDD. SPEC.	TITLE: RJ45 (A型)	
TOLERANCE UNLESS OTHERWISE SPECIFIED	PKG. SPEC.	www.kinnox.com 0755-89737484 Fax:0755-89737017	
.X±0.10	APR.	金美电子有限公司 Kinnox electronic co.,limited	
.XX±0.05	CHK.	PART NUMBER: RJ45-01A-40	
.XXX±0.03	DRA.	FILE NO.	REV: A/0
		SHEET 1/1	SCALE: 1:1