

**PRODUCT** : LCD MODULE**MODEL NO.** : TFT-G320240DTSW-71W-E**SUPPLIER** : TRULY SEMICONDUCTORS LTD.**DATE** : February 14, 2008

CERT. No QAC0946535 (ISO9001) CERT. No. HKG002005 (ISO14001)

# SPECIFICATION

Revision: 1.5

## TFT-G320240DTSW-71W-E

This module uses ROHS material

This specification maybe changed without any notice in order to improve performance or quality etc. Please contact TRULY R&D department for update specification and product status before design for this product or release the order.

**TRULY SEMICONDUCTORS LTD:**

**CUSTOMER:**

Quality Assurance Department: \_\_\_\_\_  
 Approved by: \_\_\_\_\_  
 Technical Department: \_\_\_\_\_

Approved by: \_\_\_\_\_



# CONTENTS

- GENERAL INFORMATION
- EXTERNAL DIMENSIONS
- ABSOLUTE MAXIMUM RATINGS
- ELECTRICAL CHARACTERISTICS
- TIMING OF POWER SUPPLY
- BACKLIGHT CHARACTERISTICS
- ELECTRO-OPTICAL CHARACTERISTICS
- INTERFACE DESCRIPTION
- REFERENCE APPLICATION CIRCUIT
- REFERENCE INITIAL CODE
- RELIABILITY TEST
- INSPECTION CRITERION
- PRECAUTIONS FOR USING LCD MODULES
- PACKING SPECIFICATION
- PRIOR CONSULT MATTER
- FACTORY CONTACT INFORMATION

<b>WRITTEN BY</b>	<b>CHECKED BY</b>	<b>APPROVED BY</b>
WAN HUI JUAN	LIU YAN DONG	ZHU JIN BAO

### GENERAL INFORMATION

Item	Contents	Unit
LCD Type	TFT TRANSMISSIVE	/
Viewing direction	6:00	O' Clock
outline size(W × H)	77.00×64.00	mm <sup>2</sup>
Viewing area (W×H)	72.88×55.36	mm <sup>2</sup>
Active area (W×H)	70.08×52.56	mm <sup>2</sup>
Number of Dots	320×3 (RGB) × 240	/
Driver IC	HX8238	/
Module Power consumption	430	mw
Interface Type	System serial interface/RGB interface	/
Input voltage	3.3V	V

### EXTERNAL DIMENSIONS

Customer No.: TRULY

PN	NAME	PN	NAME
1	LED-	21	DATAL9
2	LED+	22	DATAL8
3	LED+	23	DATAL1
4	LED+	24	NC
5	GNP	25	NC
6	VINO	26	DATAL8
7	VINO	27	DATAL3
8	VINO	28	DATAL4
9	VINO	29	DATAL5
10	GNP	40	DATAL8
11	NC	41	DATAL7
12	NC	42	HSYNC
13	NC	43	VSINC
14	RESET	44	DOTCLK
15	CS	45	NC
16	SDI	46	NC
17	SDI	47	VSDIG/VIC
18	NC	48	VSDIG/VIC
19	NC	49	NC
20	DATAL	50	NC
21	DATAL	51	NC
22	DATAL	52	NC
23	DATAL	53	NC
24	DATAL	54	NC
25	DATAL	55	NC
26	NC	56	NC
27	NC	57	NC
28	DATAL	58	ENABLE
29	DATAL	59	GNP
30	DATAL	60	GNP

NOTES:  
 1. DISPLAY TYPE: TFT/ Transmissive  
 2. OPERATING TEMP: -20°C~70°C  
 3. STORAGE TEMP: -30°C~80°C  
 4. DRIVE IC: HX8238-A  
 5. CONNECTOR: FF0360SA1(JAE)  
 6. ROHS COMPLIANT 环保标准  
 7. GENERAL TOLERANCE: ±0.2

LED CIRCUIT DIAGRAM:

CUSTOMER APPROVE		AMEND	
Mechanical	Electrical		
		改善光	20080118
		CHANGE COG NO.	20071023
		ND.	CONTENT DATE

<b>TRULY SEMICONDUCTORS LTD.</b>			
PRODUCT NO.	DRAW NO.	REV	
TFT-G320240DTSW-71W-E	LCM0380	C	
DWN 林汉良 20070518	BSN 林汉良 20070518		
CHKD 尹少植 20070518	APPD 陈向阳 20070518		
NOT IN SCALE UNIT mm SHEET: 1/1			

**■ ABSOLUTE MAXIMUM RATINGS**

Parameter	Symbol	Min	Max	Unit
Supply voltage for logic	V <sub>DDIO</sub>	-0.3	6.5	V
Supply voltage for analog	V <sub>DC</sub>	-0.3	6.5	V
Input voltage	V <sub>IN</sub>	-0.3	V <sub>DDIO</sub> +0.3	V
Operating temperature	T <sub>OP</sub>	-20	70	°C
Storage temperature	T <sub>ST</sub>	-30	80	°C
Humidity	RH	-	90%(Max60°C)	RH

**■ ELECTRICAL CHARACTERISTICS**

## DC CHARACTERISTICS

Parameter	Symbol	Min	Typ	Max	Unit
Power supply voltage	V <sub>DDIO</sub>	1.65	3.3	3.6	V
	V <sub>DC</sub>	2.4	3.3	3.6	V
Input Current	I <sub>dd</sub>	-	10.4	20.8	Ma
Input voltage 'H' level	V <sub>IH</sub>	0.8 V <sub>DDIO</sub>	-	V <sub>DDIO</sub>	V
Input voltage 'L' level	V <sub>IL</sub>	0	-	0.2 V <sub>DDIO</sub>	V
Output voltage 'H' level	V <sub>OH</sub>	0.9 V <sub>DDIO</sub>	-	V <sub>DDIO</sub>	V
Output voltage 'L' level	V <sub>OL</sub>	0	-	0.1 V <sub>DDIO</sub>	V

**■ TIMING OF POWER SUPPLY**

PLEASE REFER TO THE DRIVER IC SPECIFICATION.

**■ BACKLIGHT CHARACTERISTICS**

Item	Symbol	Min.	Typ.	Max.	Unit	Condition
Forward voltage	V <sub>f</sub>	18.0	18.9	19.8	V	If=15mA
Luminance	L <sub>v</sub>	2000	2500	3000	cd/m <sup>2</sup>	
Number of LED	-	6			Piece	-
Connection mode	S	series			-	-
LED Life		30000			H	If=15mA Ta=23±3°C

**■ELECTRO-OPTICAL CHARACTERISTICS**

Item	Symbol	Condition	Min	Typ	Max	Unit	Remark	Note
Response time	Tr +Tf	θ=0° ∅=0° Ta=25°C	---	54.9	82.35	ms	FIG 1.	4
Contrast ratio	Cr		138	276	---	---	FIG 2.	1
Luminance uniformity	δ WHITE		81	90	---	%	FIG 2.	3
Surface Luminance	Lv		256	320	---	cd/m <sup>2</sup>	FIG 2.	2
Viewing angle range	θ	∅ = 90°	40	50	---	deg	FIG 3.	6
		∅ = 270°	70	80	---	deg	FIG 3.	
		∅ = 0°	70	80	---	deg	FIG 3.	
		∅ = 180°	65	75	---	deg	FIG 3.	
CIE (x, y) chromaticity	Red	x	0.563	0.613	0.663	FIG 2.	5	
		y	0.315	0.365	0.415			
	Green	x	0.300	0.350	0.400			
		y	0.539	0.589	0.639			
	Blue	x	0.097	0.147	0.197			
		y	0.026	0.076	0.126			
	White	x	0.253	0.313	0.373			
		y	0.267	0.327	0.387			

Note 1. Contrast Ratio(CR) is defined mathematically as For more information see FIG 2.

$$\text{Contrast Ratio} = \frac{\text{Average Surface Luminance with all white pixels (P1, P2, P3, P4, P5)}}{\text{Average Surface Luminance with all black pixels (P1, P2, P 3,P4, P5)}}$$

Note 2. Surface luminance is the LCD surface from the surface with all pixels displaying white. For more information see FIG 2.

$$L_v = \text{Average Surface Luminance with all white pixels (P1, P2, P 3, P4, P5)}$$

Note 3. The uniformity in surface luminance , δ WHITE is determined by measuring luminance at each test position 1 through 5, and then dividing the maximum luminance of 5 points luminance by minimum luminance of 5 points luminance. For more information see FIG 2.

$$\delta \text{ WHITE} = \frac{\text{Minimum Surface Luminance with all white pixels (P1, P2, P 3, P4, P5)}}{\text{Maximum Surface Luminance with all white pixels (P1, P2, P 3, P4, P5)}}$$

Note 4. Response time is the time required for the display to transition from White to black(Rise Time, Tr) and from black to white(Decay Time, Tf). For additional information see FIG 1. The test equipment is Autronic-Melchers’s ConoScope. Series.

Note 5. CIE (x, y) chromaticity, The x, y value is determined by measuring luminance at each test position 1 through 5,and then make average value.

Note 6. Viewing angle is the angle at which the contrast ratio is greater than 2. For TFT module the contrast ratio is greater than 10. The angles are determined for the horizontal or x axis and the vertical or y axis with respect to the z axis which is normal to the LCD surface. For more information see FIG 3.

Note7. For viewing angle and response time testing, the testing data is base on Autronic-Melchers’s ConoScope. Series Instruments For contrast ratio, Surface Luminance, Luminance uniformity, CIE The test data is base on TOPCON’s BM-5 photo detector.

**FIG. 1 The definition of Response Time**

The response time is defined as the following figure and shall be measured by switching the input signal for "black" and "white".

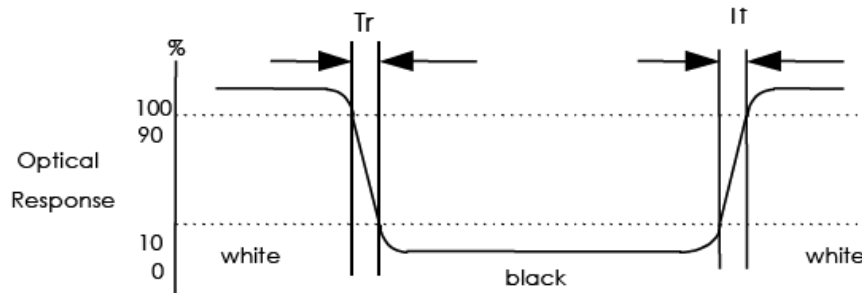

**FIG. 2 Measuring method for Contrast ratio, surface luminance, Luminance uniformity , CIE (x, y) chromaticity**

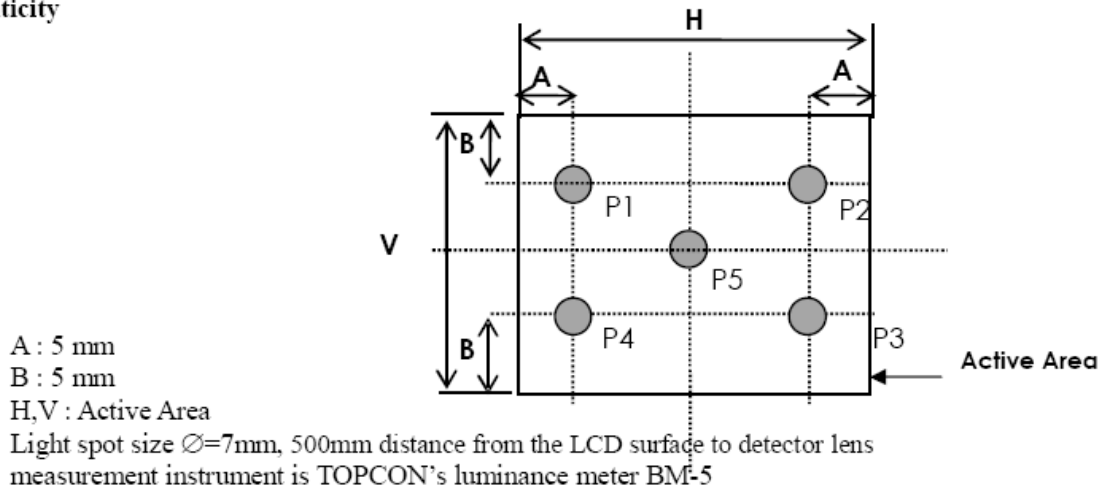

**FIG. 3 The definition of viewing angle**

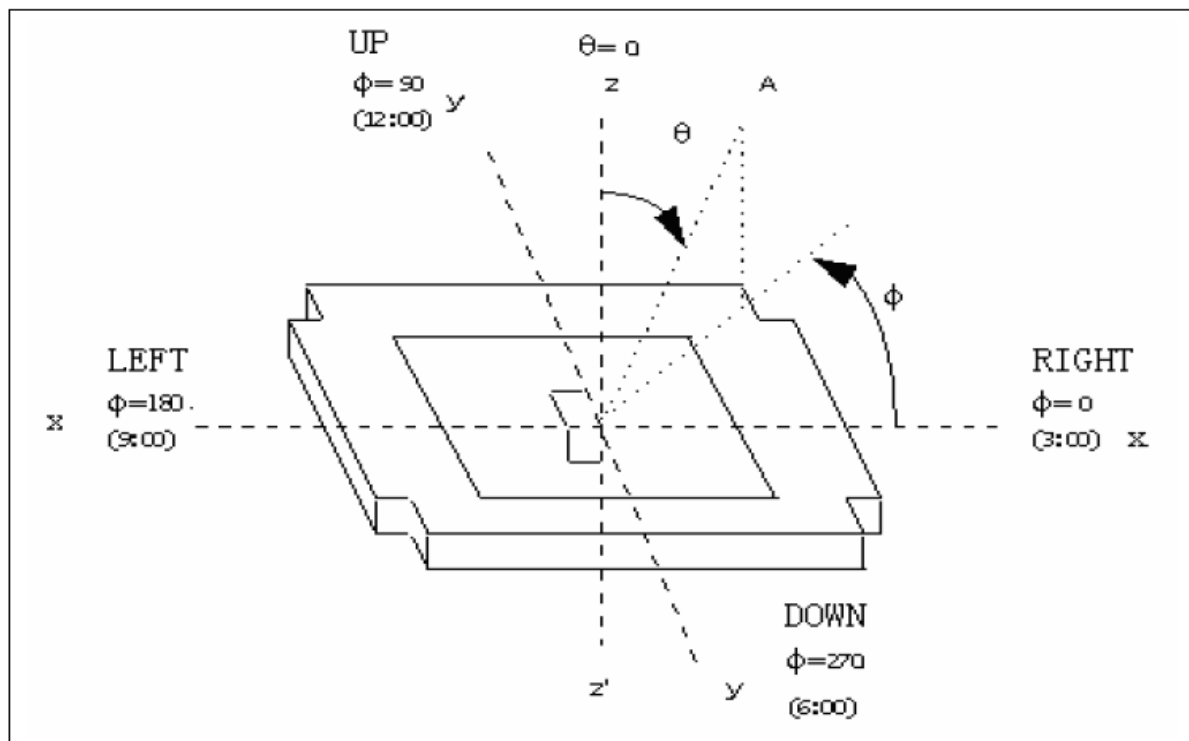

**■ INTERFACE DESCRIPTION**

Pin	Symbol	I/O	Description	Remark
1	LED-	I	LED Cathode	
2	LED-	I	LED_Cathode	
3	LED+	I	LED_Anode	
4	LED+	I	LED_Anode	
5	GND	I/O	Ground	
6	X1 (NC)	I	NC	
7	Y1 (NC)	I	NC	
8	X2 (NC)	I	NC	
9	Y2 (NC)	I	NC	
10	GND		Ground	
11	NC		NC	
12	NC		NC	
13	NC		NC	
14	RESET	I	Reset	
15	CS	I	Chip Select	
16	SCL	I	Serial Clock	
17	SDI	I	Serial Data	
18	NC		NC	
19	NC		NC	
20	DATA0	I	Blue Data(LSB)	
21	DATA1	I	Blue Data	
22	DATA2	I	Blue Data	
23	DATA3	I	Blue Data	
24	DATA4	I	Blue Data	
25	DATA5	I	Blue Data(MSB)	
26	NC		NC	
27	NC		NC	
28	DATA6	I	Green Data(LSB)	
29	DATA7	I	Green Data	
30	DATA8	I	Green Data	
31	DATA9	I	Green Data	
32	DATA10	I	Green Data	
33	DATA11	I	Green Data(MSB)	



34	NC		NC	
35	NC		NC	
36	DATA12	I	Red Data(LSB)	
37	DATA13	I	Red Data	
38	DATA14	I	Red Data	
39	DATA15	I	Red Data	
40	DATA16	I	Red Data	
41	DATA17	I	Red Data(MSB)	
42	HSYNC	I	Horizontal Synchronous Signal	
43	VSYNC	I	Vertical Synchronous Signal	
44	DOTCLK	I	Data Colck	
45	NC		NC	
46	NC		NC	
47	VDDIO/VDC	I	Vdigital/ Vanalog power source	Typ=3.3V
48	VDDIO/VDC	I	Vdigital/ Vanalog power source	Typ=3.3V
49	NC		NC	
50	NC		NC	
51	NC		NC	
52	NC		NC	
53	NC		NC	
54	NC		NC	
55	NC		NC	
56	NC		NC	
57	NC		NC	
58	ENABLE	I	Data enabling signal	
59	GND	I/O	Ground	
60	GND	I/O	Ground	

## ■ APPLICATION CIRCUIT

Please consult our technical department for detail information.

## ■ INITIAL CODE

Please consult our technical department for detail information.

**■ RELIABILITY TEST**

No.	Test Item	Test Condition	Inspection after test
1	High Temperature Storage	80±2°C/200 hours	Inspection after 2~4 hours storage at room temperature, the sample shall be free from defects: 1.Air bubble in the LCD; 2.Sealleak; 3.Non-display; 4.missing segments; 5.Glass crack; 6.Current Idd is twice higher than initial value.
2	Low Temperature Storage	-30±2°C/200 hours	
3	High Temperature Operating	70±2°C/120 hours	
4	Low Temperature Operating	-20±2°C/120 hours	
5	Temperature Cycle	-20 ± 2 °C ~25~70 ± 2 °C × 10cycles (30min.) (5min.) (30min.)	
6	Damp Proof Test	50°C±5°C×90%RH/120 hours	
7	Vibration Test	Frequency: 10Hz~55Hz~10Hz Amplitude: 1.5mm, X, Y, Z direction for total 3hours (Packing condition)	
8	Drooping test	Drop to the ground from 1m height, one time, every side of carton. (Packing condition)	
9	ESD test	Voltage:±8KV R: 330Ω C: 150pF Air discharge, 10time	

**Remark:**

- 1.The test samples should be applied to only one test item.
- 2.Sample size for each test item is 5~10pcs.
- 3.For Damp Proof Test, Pure water(Resistance>10MΩ) should be used.
- 4.In case of malfunction defect caused by ESD damage, if it would be recovered to normal state after resetting, it would be judge as a good part.  
Using ionizer(an antistatic blower) is recommended at working area in order to reduce electro-static voltage.  
When removing protection film from LCM panel, peel off the tag slowly( recommended more than one second) while blowing with ionizer toward the peeling face to minimize ESD which may damage electrical circuit.
- 5.EL evaluation should be excepted from reliability test with humidity and temperature: Some defects such as black spot/blemish can happen by natural chemical reaction with humidity and Fluorescence EL has.
- 6.Please use automatic switch menu(or roll menu) testing mode when test operating mode.

**■ INSPECTION CRITERION**

<b>TRULY</b> <sup>®</sup> OUTGOING QUALITY STANDARD	P.1 of 5
TITLE:FUNCTIONAL TEST & INSPECTION CRITERIA	Normal LCM Product

This specification is made to be used as the standard acceptance/rejection criteria for Normal LCM Product.

## 1 Sample plan

Sampling plan according to GB/T2828.1-2003/ISO 2859-1: 1999 and ANSI/ASQC Z1.4-1993, normal level 2 and based on:

Major defect: AQL 0.65

Minor defect: AQL 1.5

## 2. Inspection condition

● Viewing distance for cosmetic inspection is about 30cm with bare eyes, and under an environment of 20~40W light intensity, all directions for inspecting the sample should be within 45° against perpendicular line. (Normal temperature 20~25°C and normal humidity 60±15%RH).

## ● Driving voltage

The Vop value from which the most optimal contrast can be obtained near the specified Vop in the specification (Within ±0.5V of the typical value at 25°C.).

## 3. Definition of inspection zone in LCD.

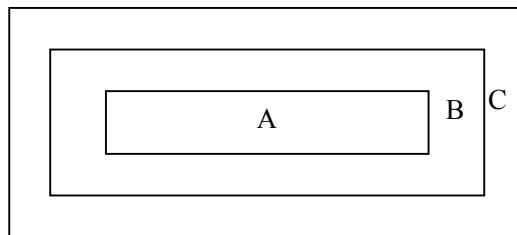

Zone A: character/Digit area

Zone B: viewing area except Zone A (ZoneA+ZoneB=minimum Viewing area)

Zone C: Outside viewing area (invisible area after assembly in customer's product)

Fig.1 Inspection zones in an LCD.

Note: As a general rule, visual defects in Zone C are permissible, when it is no trouble for quality and assembly of customer's product.

<b>TRULY</b> ® OUTGOING QUALITY STANDARD	P.2 of 5
TITLE:FUNCTIONAL TEST & INSPECTION CRITERIA	Normal LCM Product

## 4. Inspection Standard

### 4.1 Major Defect

Item No	Items to be inspected	Inspection Standard	Classification of defects
4.1.1	All functional defects	1) No display 2) Display abnormally 3) Missing vertical, horizontal segment 4) Short circuit 5) Back-light no lighting, flickering and abnormal lighting.	Major
4.1.2	Missing	Missing component	
4.1.3	Outline dimension	Overall outline dimension beyond the drawing is not allowed.	

### 4. 2 Cosmetic Defect

#### 4.2.1 Module Cosmetic Criteria

No.	Item	Judgement Criterion	Partition
1	Difference in Spec.	None allowed	Major
2	Pattern peeling	No substrate pattern peeling and floating	Major
3	Soldering defects	No soldering missing No soldering bridge No cold soldering	Major Major Minor
4	Resist flaw on Printed Circuit Boards	visible copper foil (Ø0.5mm or more) on substrate pattern	Minor
5	Accretion of metallic Foreign matter	No accretion of metallic foreign matters (Not exceed Ø0.2mm)	Minor Minor
6	Stain	No stain to spoil cosmetic badly	Minor
7	Plate discoloring	No plate fading, rusting and discoloring	Minor
8	Solder amount	a. Soldering side of PCB Solder to form a 'Filet' all around the lead. Solder should not hide the lead form perfectly. (too much)	Minor
	1. Lead parts	b. Components side ( In case of 'Through Hole PCB' )  Solder to reach the Components side of PCB.	
	2. Flat packages	Either 'Toe' (A) or 'Seal' (B) of the lead to be covered by 'Filet'.  Lead form to be assume over solder.	Minor
	3. Chips	$(3/2) H \geq h \geq (1/2) H$	Minor



OUTGOING QUALITY STANDARD	P.4 of 5
TITLE:FUNCTIONAL TEST & INSPECTION CRITERIA	Normal LCM Product

### 4. 2. 3 Cosmetic Criteria (Operating)

No.	Defect	Judgment Criterion	Partition																																												
1	Spots	A) I Clear <table border="1" style="margin-top: 10px;"> <thead> <tr> <th>Lcd size</th> <th>Size : d mm</th> <th>Acceptable Qty in active area</th> </tr> </thead> <tbody> <tr> <td rowspan="4" style="text-align: center;">Lcd size ≤ 8.0'</td> <td>d ≤ 0.1</td> <td style="text-align: center;">Disregard</td> </tr> <tr> <td>0.1 &lt; d ≤ 0.2</td> <td style="text-align: center;">6</td> </tr> <tr> <td>0.2 &lt; d ≤ 0.3</td> <td style="text-align: center;">2</td> </tr> <tr> <td>0.3 &lt; d</td> <td style="text-align: center;">0</td> </tr> <tr> <td rowspan="4" style="text-align: center;">Lcd size &gt; 8.0'</td> <td>d ≤ 0.1</td> <td style="text-align: center;">Disregard</td> </tr> <tr> <td>0.1 &lt; d ≤ 0.3</td> <td style="text-align: center;">10</td> </tr> <tr> <td>0.3 &lt; d ≤ 0.5</td> <td style="text-align: center;">5</td> </tr> <tr> <td>0.5 &lt; d</td> <td style="text-align: center;">0</td> </tr> </tbody> </table> <p>Note : Including pin holes and defective dots which must be within one pixel size; Total defective point shall not exceed 6 pcs no more than 8 inch LCD and 10PCS for more than 8 inch LCD.</p> B) Unclear <table border="1" style="margin-top: 10px;"> <thead> <tr> <th>Lcd size</th> <th>Size : d mm</th> <th>Acceptable Qty in active area</th> </tr> </thead> <tbody> <tr> <td rowspan="4" style="text-align: center;">Lcd size ≤ 8.0'</td> <td>d ≤ 0.2</td> <td style="text-align: center;">Disregard</td> </tr> <tr> <td>0.2 &lt; d ≤ 0.5</td> <td style="text-align: center;">6</td> </tr> <tr> <td>0.5 &lt; d ≤ 0.7</td> <td style="text-align: center;">2</td> </tr> <tr> <td>0.7 &lt; d</td> <td style="text-align: center;">0</td> </tr> <tr> <td rowspan="5" style="text-align: center;">Lcd size &gt; 8.0'</td> <td>d ≤ 0.2</td> <td style="text-align: center;">Disregard</td> </tr> <tr> <td>0.2 &lt; d ≤ 0.5</td> <td style="text-align: center;">10</td> </tr> <tr> <td>0.5 &lt; d ≤ 0.7</td> <td style="text-align: center;">3</td> </tr> <tr> <td>0.7 &lt; d ≤ 1.0</td> <td style="text-align: center;">1</td> </tr> <tr> <td>1.0 &lt; d</td> <td style="text-align: center;">0</td> </tr> </tbody> </table> <p>Note : Total defective point shall not exceed 6 pcs for no more than 8 inch LCD and 10PCS for more than 8 inch LCD.</p>	Lcd size	Size : d mm	Acceptable Qty in active area	Lcd size ≤ 8.0'	d ≤ 0.1	Disregard	0.1 < d ≤ 0.2	6	0.2 < d ≤ 0.3	2	0.3 < d	0	Lcd size > 8.0'	d ≤ 0.1	Disregard	0.1 < d ≤ 0.3	10	0.3 < d ≤ 0.5	5	0.5 < d	0	Lcd size	Size : d mm	Acceptable Qty in active area	Lcd size ≤ 8.0'	d ≤ 0.2	Disregard	0.2 < d ≤ 0.5	6	0.5 < d ≤ 0.7	2	0.7 < d	0	Lcd size > 8.0'	d ≤ 0.2	Disregard	0.2 < d ≤ 0.5	10	0.5 < d ≤ 0.7	3	0.7 < d ≤ 1.0	1	1.0 < d	0	Minor
Lcd size	Size : d mm	Acceptable Qty in active area																																													
Lcd size ≤ 8.0'	d ≤ 0.1	Disregard																																													
	0.1 < d ≤ 0.2	6																																													
	0.2 < d ≤ 0.3	2																																													
	0.3 < d	0																																													
Lcd size > 8.0'	d ≤ 0.1	Disregard																																													
	0.1 < d ≤ 0.3	10																																													
	0.3 < d ≤ 0.5	5																																													
	0.5 < d	0																																													
Lcd size	Size : d mm	Acceptable Qty in active area																																													
Lcd size ≤ 8.0'	d ≤ 0.2	Disregard																																													
	0.2 < d ≤ 0.5	6																																													
	0.5 < d ≤ 0.7	2																																													
	0.7 < d	0																																													
Lcd size > 8.0'	d ≤ 0.2	Disregard																																													
	0.2 < d ≤ 0.5	10																																													
	0.5 < d ≤ 0.7	3																																													
	0.7 < d ≤ 1.0	1																																													
	1.0 < d	0																																													
2	Lines	A) Clear <p style="margin-left: 20px;">L 5.0 2.0 ∞ 0.02 0.05 0.1 W</p> <p style="margin-left: 20px;">(0) (6) See No. 1</p> <p>Note : ( ) - Acceptable Qty in active area L - Length (mm) W - Width (mm) ∞ - Disregard</p> B) Unclear <p style="margin-left: 20px;">L 10.0 2.0 ∞ 0.02 0.05 0.1 W</p> <p style="margin-left: 20px;">(0) (6) See No. 1</p> <p>'Clear' = The shade and size are not changed by V<sub>op</sub>. 'Unclear' = The shade and size are changed by V<sub>op</sub>.</p>	Minor																																												

OUTGOING QUALITY STANDARD			P.5 of 5
TITLE:FUNCTIONAL TEST & INSPECTION CRITERIA			Normal LCM Product
3	Rubbing line	Not to be noticeable.	Minor
4	Allowable density	Above defects should be separated more than 10mm each other.	Minor
5	Rainbow	Not to be noticeable.	Minor
6	Dot size	To be 95% ~ 105% of the dot size (Typ.) in drawing. Partial defects of each dot (ex. pin-hole) should be treated as 'Spot'. (see <i>Screen Cosmetic Criteria (Operating) No.1</i> )	Minor
7	Uneven brightness (only back-lit type module)	Uneven brightness must be $B_{MAX} / B_{MIN} \leq 2$ - $B_{MAX}$ : Max. value by measure in 5 points - $B_{MIN}$ : Min. value by measure in 5 points Divide active area into 4 vertically and horizontally. Measure 5 points shown in the following figure.	Minor

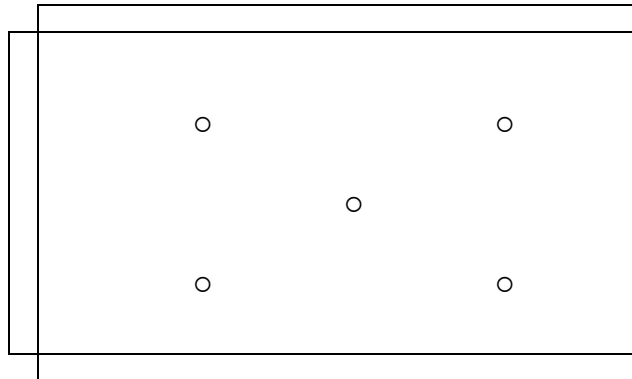

○ : Measuring points

## Note :

- (1) Size :  $d = (\text{long length} + \text{short length}) / 2$
- (2) The limit samples for each item have priority.
- (3) Complex defects are defined item by item, but if the numbers of defects are defined in above table, the total number should not exceed 10.
- (4) In case of 'concentration', even the spots or the lines of 'disregarded' size should not allowed. Following three situations should be treated as 'concentration'.
  - 7 or over defects in circle of  $\varnothing 5\text{mm}$ .
  - 10 or over defects in circle of  $\varnothing 10\text{mm}$ .
  - 20 or over defects in circle of  $\varnothing 20\text{mm}$ .

**■ PRECAUTIONS FOR USING LCD MODULES****Handling Precautions**

(1) The display panel is made of glass and polarizer. As glass is fragile. It tends to become or chipped during handling especially on the edges. Please avoid dropping or jarring. Do not subject it to a mechanical shock by dropping it or impact.

(2) If the display panel is damaged and the liquid crystal substance leaks out, be sure not to get any in your mouth. If the substance contacts your skin or clothes, wash it off using soap and water.

(3) Do not apply excessive force to the display surface or the adjoining areas since this may cause the color tone to vary. Do not touch the display with bare hands. This will stain the display area and degraded insulation between terminals (some cosmetics are determined to the polarizer).

(4) The polarizer covering the display surface of the LCD module is soft and easily scratched. Handle this polarizer carefully. Do not touch, push or rub the exposed polarizers with anything harder than an HB pencil lead (glass, tweezers, etc.). Do not put or attach anything on the display area to avoid leaving marks on. Condensation on the surface and contact with terminals due to cold will damage, stain or dirty the polarizer. After products are tested at low temperature they must be warmed up in a container before coming is contacting with room temperature air.

(5) If the display surface becomes contaminated, breathe on the surface and gently wipe it with a soft dry cloth. If it is heavily contaminated, moisten cloth with one of the following solvents

- Isopropyl alcohol
- Ethyl alcohol

Do not scrub hard to avoid damaging the display surface.

(6) Solvents other than those above-mentioned may damage the polarizer. Especially, do not use the following.

- Water
- Ketone
- Aromatic solvents

Wipe off saliva or water drops immediately, contact with water over a long period of time may cause deformation or color fading. Avoid contacting oil and fats.

(7) Exercise care to minimize corrosion of the electrode. Corrosion of the electrodes is accelerated by water droplets, moisture condensation or a current flow in a high-humidity environment.

(8) Install the LCD Module by using the mounting holes. When mounting the LCD module make sure it is free of twisting, warping and distortion. In particular, do not forcibly pull or bend the I/O cable or the backlight cable.

(9) Do not attempt to disassemble or process the LCD module.

(10) NC terminal should be open. Do not connect anything.

(11) If the logic circuit power is off, do not apply the input signals.

(12) Electro-Static Discharge Control, Since this module uses a CMOS LSI, the same careful attention should be paid to electrostatic discharge as for an ordinary CMOS IC. To prevent destruction of the elements by static electricity, be careful to maintain an optimum work environment.

- Before remove LCM from its packing case or incorporating it into a set, be sure the module and your body have the same electric potential. Be sure to ground the body when handling the LCD modules.

- Tools required for assembling, such as soldering irons, must be properly grounded. make certain the AC power source for the soldering iron does not leak. When using an electric screwdriver to attach LCM, the screwdriver should be of ground potentiality to minimize as much as possible any transmission of electromagnetic waves produced sparks coming from the commutator of the motor.

- To reduce the amount of static electricity generated, do not conduct assembling and other work under dry conditions. To reduce the generation of static electricity be careful that the air in the work is not too dried. A relative humidity of 50%-60% is recommended. As far as possible make the electric potential of your work clothes and that of the work bench the ground potential

- The LCD module is coated with a film to protect the display surface. Exercise care when peeling off this protective film since static electricity may be generated



(13) Since LCM has been assembled and adjusted with a high degree of precision, avoid applying excessive shocks to the module or making any alterations or modifications to it.

- Do not alter, modify or change the shape of the tab on the metal frame.
- Do not make extra holes on the printed circuit board, modify its shape or change the positions of components to be attached.
- Do not damage or modify the pattern writing on the printed circuit board.
- Absolutely do not modify the zebra rubber strip (conductive rubber) or heat seal connector.
- Except for soldering the interface, do not make any alterations or modifications with a soldering iron.
- Do not drop, bend or twist LCM.

#### Handling precaution for LCM

LCM is easy to be damaged.

Please note below and be careful for handling!

#### **Correct handling:**



As above picture, please handle with anti-static gloves around LCM edges.

#### **Incorrect handling:**

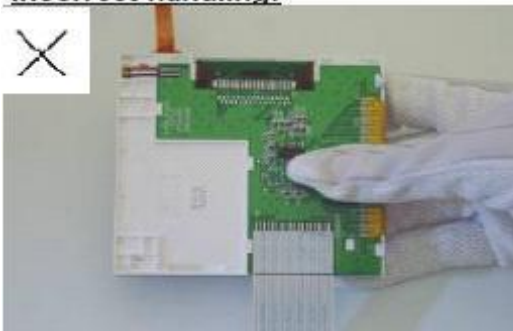

Please don't touch IC directly.



Please don't stack LCM.

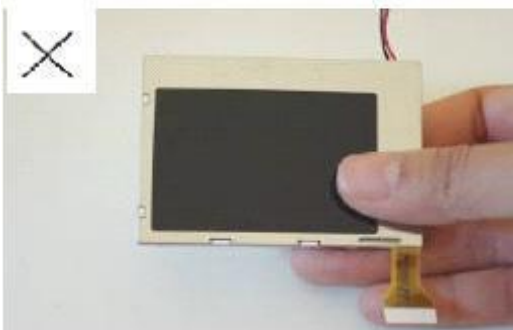

Please don't hold the surface of panel.

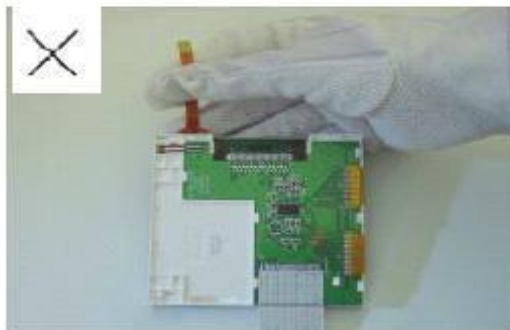

Please don't stretch interface of output, such as FPC cable.

## Handling precaution for LCD

LCD is easy to be damaged.  
Please note below and be careful for handling!

### Correct handling:

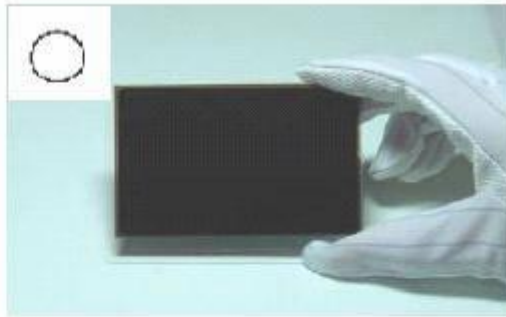

As above photo, please handle with anti-static gloves around LCD edges.

### Incorrect handling:



Please don't stack the LCDS.

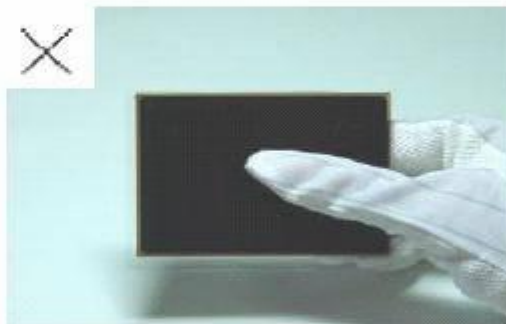

Please don't hold the surface of LCD.

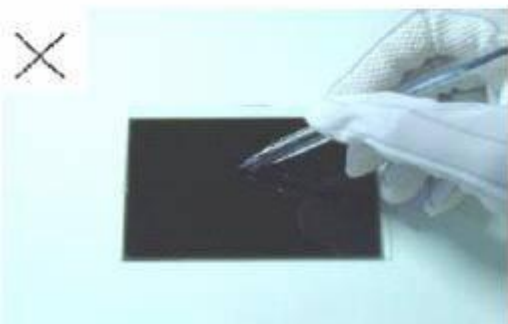

Please don't operate with sharp stick such as pens.

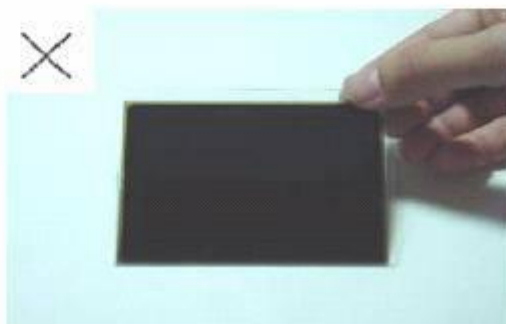

Please don't touch ITO glass without anti-static gloves.

### Storage Precautions

When storing the LCD modules, the following precaution is necessary.

- (1) Store them in a sealed polyethylene bag. If properly sealed, there is no need for the dessicant.
- (2) Store them in a dark place. Do not expose to sunlight or fluorescent light, keep the temperature between 0°C and 35°C, and keep the relative humidity between 40%RH and 60%RH.
- (3) The polarizer surface should not come in contact with any other objects. (We advise you to store them in the anti-static electricity container in which they were shipped.

### Others

Liquid crystals solidify under low temperature (below the storage temperature range) leading to defective orientation or the generation of air bubbles (black or white). Air bubbles may also be generated if the module is subject to a low temperature.

If the LCD modules have been operating for a long time showing the same display patterns, the display patterns may remain on the screen as ghost images and a slight contrast irregularity may also appear. A normal operating status can be regained by suspending use for some time. It should be noted that this phenomenon does not adversely affect performance reliability.

To minimize the performance degradation of the LCD modules resulting from destruction caused by static electricity etc., exercise care to avoid holding the following sections when handling the modules.

- Exposed area of the printed circuit board.
- Terminal electrode sections.

## ■ USING LCD MODULES

### Installing LCD Modules

The hole in the printed circuit board is used to fix LCM as shown in the picture below. Attend to the following items when installing the LCM.

- (1) Cover the surface with a transparent protective plate to protect the polarizer and LC cell.

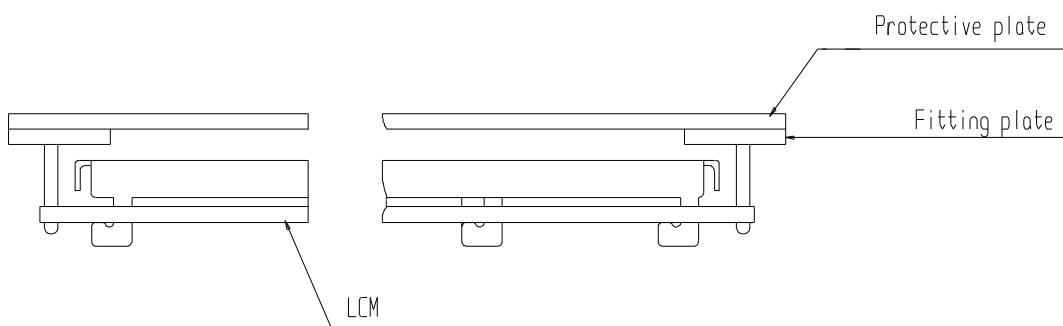

- (2) When assembling the LCM into other equipment, the spacer to the bit between the LCM and the fitting plate should have enough height to avoid causing stress to the module surface, refer to the individual specifications for measurements. The measurement tolerance should be  $\pm 0.1$  mm.

Precaution for assemble the module with BTB connector:

Please note the position of the male and female connector position, don't assemble or assemble like the method which the following picture shows

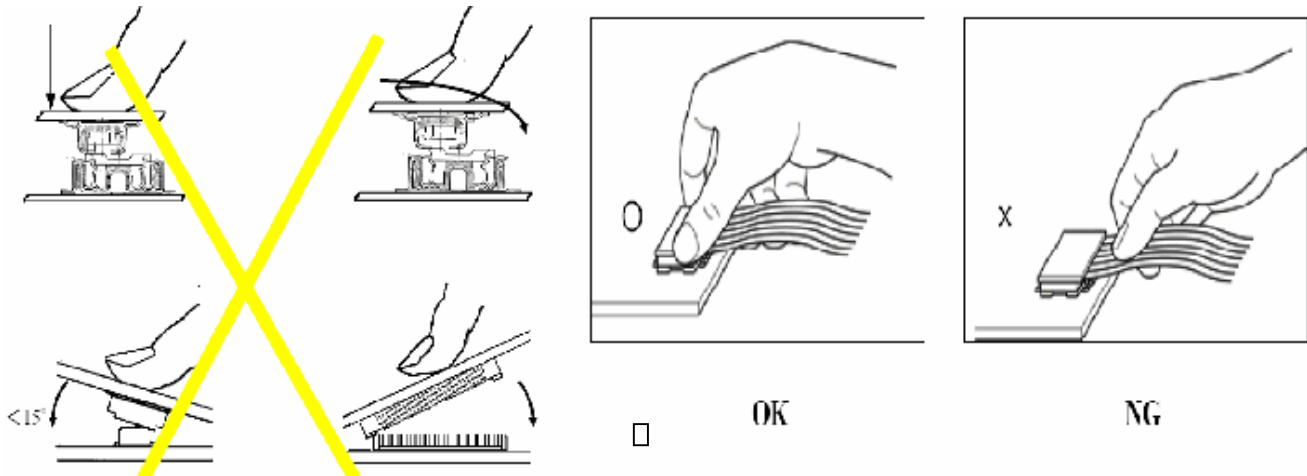

Precaution for soldering the LCM

	Manual soldering	Machine drag soldering	Machine press soldering
No ROHS product	290°C ~350°C. Time : 3-5S.	330°C ~350°C. Speed : 4-8 mm/s.	300°C ~330°C. Time : 3-6S. Press: 0.8~1.2Mpa
ROHS product	340°C ~370°C. Time : 3-5S.	350°C ~370°C. Time : 4-8 mm/s.	330°C ~360°C. Time : 3-6S. Press: 0.8~1.2Mpa

(1) If soldering flux is used, be sure to remove any remaining flux after finishing to soldering operation. (This does not apply in the case of a non-halogen type of flux.) It is recommended that you protect the LCD surface with a cover during soldering to prevent any damage due to flux spatters.

(2) When soldering the electroluminescent panel and PC board, the panel and board should not be detached more than three times. This maximum number is determined by the temperature and time conditions mentioned above, though there may be some variance depending on the temperature of the soldering iron.

(3) When remove the electroluminescent panel from the PC board, be sure the solder has completely melted, the soldered pad on the PC board could be damaged.

Precautions for Operation

(1) Viewing angle varies with the change of liquid crystal driving voltage (VLCD). Adjust VLCD to show the best contrast.

(2) It is an indispensable condition to drive LCD's within the specified voltage limit since the higher voltage then the limit cause the shorter LCD life. An electrochemical reaction due to direct current causes LCD's undesirable deterioration, so that the use of direct current drive should be avoided.

(3) Response time will be extremely delayed at lower temperature than the operating temperature range and on the other hand at higher temperature LCD's show dark color in them. However those phenomena do not mean malfunction or out of order with LCD's, Which will come back in the specified operating temperature.

(4) If the display area is pushed hard during operation, the display will become abnormal. However, it will return to normal if it is turned off and then back on.

(5) A slight dew depositing on terminals is a cause for electro-chemical reaction resulting in terminal open circuit. Usage under the maximum operating temperature, 50%RH or less is required.

(6) Input each signal after the positive/negative voltage becomes stable.

(7) Please keep the temperature within specified range for use and storage. Polarization degradation, bubble generation or polarizer peel-off may occur with high temperature and high humidity.

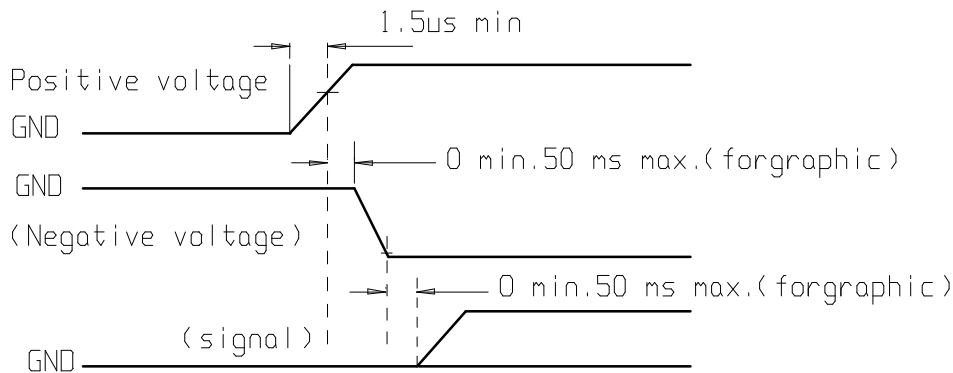

### Safety

(1) It is recommended to crush damaged or unnecessary LCDs into pieces and wash them off with solvents such as acetone and ethanol, which should later be burned.

(2) If any liquid leaks out of a damaged glass cell and comes in contact with the hands, wash off thoroughly with soap and water.

### Limited Warranty

Unless agreed between TRULY and customer, TRULY will replace or repair any of its LCD modules which are found to be functionally defective when inspected in accordance with TRULY LCD acceptance standards (copies available upon request) for a period of one year from date of shipments. Cosmetic/visual defects must be returned to TRULY within 90 days of shipment. Confirmation of such date shall be based on freight documents. The warranty liability of TRULY limited to repair and/or replacement on the terms set forth above. TRULY will not be responsible for any subsequent or consequential events.

### Return LCM under warranty

No warranty can be granted if the precautions stated above have been disregarded. The typical examples of violations are :

- Broken LCD glass.
- PCB eyelet is damaged or modified.
- PCB conductors damaged.
- Circuit modified in any way, including addition of components.
- PCB tampered with by grinding, engraving or painting varnish.
- Soldering to or modifying the bezel in any manner.

Module repairs will be invoiced to the customer upon mutual agreement. Modules must be returned with sufficient description of the failures or defects. Any connectors or cable installed by the customer must be removed completely without damaging the PCB eyelet, conductors and terminals.

### ■ PACKING SPECIFICATION

TBD

### ■ PRIOR CONSULT MATTER

1.①For Truly standard products, we keep the right to change material, process ... for improving the product property without notice on our customer.

②For OEM products, if any change needed which may affect the product property, we will consult with our customer in advance.

2.If you have special requirement about reliability condition, please let us know before you start the test on our samples.

### ■ FACTORY

FACTORY NAME: TRULY SEMICONDUCTORS LTD.

FACTORY ADDRESS: Truly Industrial Area, ShanWei City,GuangDong,China

FACTORY PHONE: 86-0660-3380061 FAX: 86-0660-3371772