

艾米电子工作室
<http://www.amy-studio.com/>
<http://shop33537127.taobao.com/>

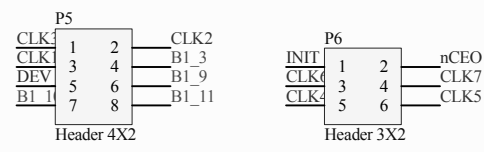

Title		
Size	Number	Revision
A4		
Date:	2008-9-21	Sheet of
File:	E:\个人工作\08-board\Nios\bank.SchDoc	Drawn By:

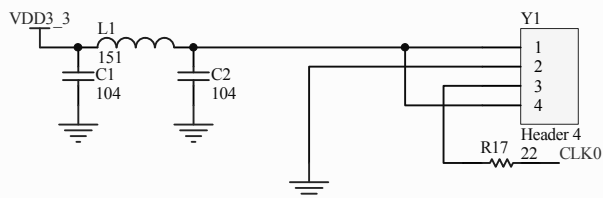
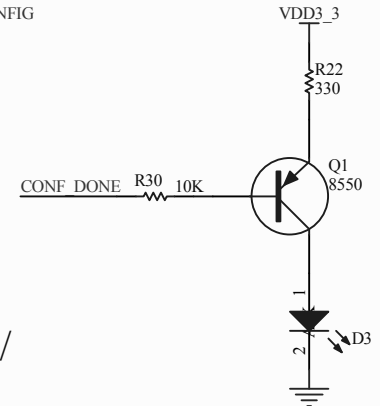
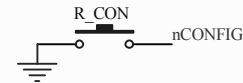
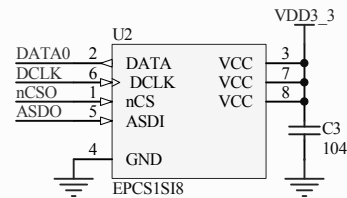
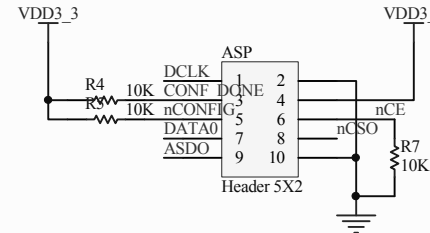
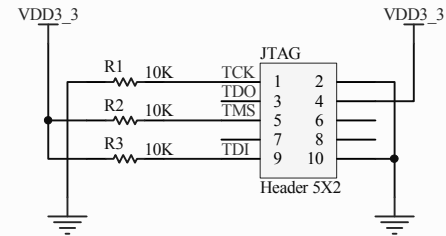
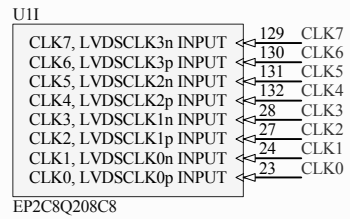
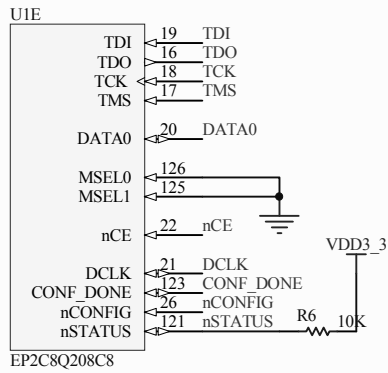

艾米电子工作室

<http://www.amy-studio.com/>

<http://shop33537127.taobao.com/>

Title		
Size A4	Number	Revision
Date: 2008-9-21	Sheet of	
File: E:\个人工作\...configure.SchDoc	Drawn By:	

1

2

3

4

A

A

B

B

C

C

D

D

U_bank
bank.SchDoc



U_configure
configure.SchDoc



U_module
module.SchDoc



U_power
power.SchDoc



U_memory
memory.SchDoc



艾米电子工作室

<http://www.amy-studio.com/>

<http://shop33537127.taobao.com/>

Title		
Size A4	Number	Revision
Date:	2008-9-21	Sheet of
File:	E:\个人工作\08-board\NIOSep2c8.SchDoc Drawn By:	

1

2

3

4

A

A

B

B

C

C

D

D

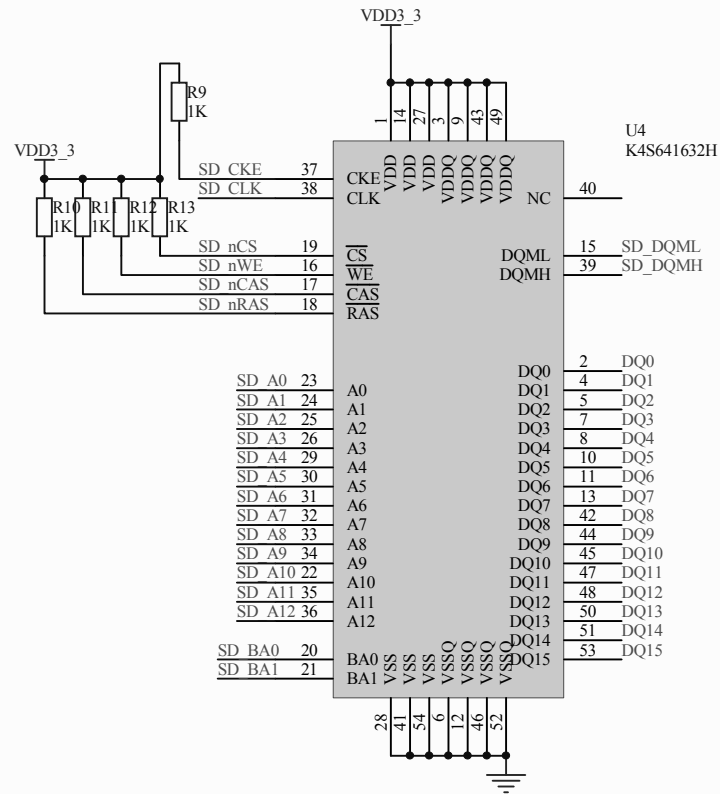
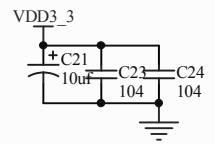

- B2 19 SD_A10
- B2 20 SD_BA1
- B2 21 SD_BA0
- B2 22 SD_nCS
- B2 23 SD_nRAS
- B2 24 SD_nCAS
- B2 25 SD_nWE
- B2 26 SD_DQML
- B2 6 SD_A4
- B2 5 SD_A5
- B2 4 SD_A6
- B2 3 SD_A7
- B2 2 SD_A8
- B2 1 SD_A9
- B3 31 SD_A11
- B3 30 SD_A12
- B3 29 SD_CKE
- B3 28 SD_CLK
- B2 7 DQ8
- B2 8 DQ9
- B2 9 DQ10
- B2 10 DQ11
- B2 11 DQ12
- B2 12 DQ13
- B2 13 DQ14
- B2 14 DQ15
- B2 27 DQ7
- B2 28 DQ6
- B2 29 DQ5
- B2 30 DQ4
- B2 31 DQ3
- B2 32 DQ2
- B2 33 DQ1
- B2 34 DQ0
- B2 35 DQ0
- B3 27 SD_DQMH
- B2 7 DQ8
- B2 8 DQ9
- B2 9 DQ10
- B2 10 DQ11
- B2 11 DQ12
- B2 12 DQ13
- B2 13 DQ14
- B2 14 DQ15
- B2 27 DQ7
- B2 28 DQ6
- B2 29 DQ5
- B2 30 DQ4
- B2 31 DQ3
- B2 32 DQ2
- B2 33 DQ1
- B2 34 DQ0
- B2 35 DQ0
- B3 27 SD_DQMH

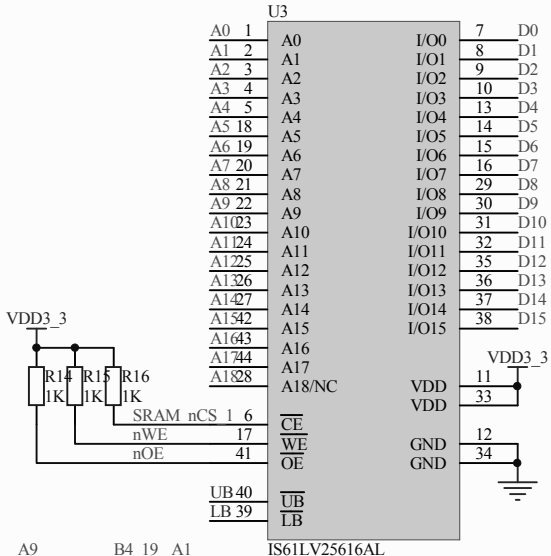

- B4 1 A9
- B4 2 A8
- B4 3 A7
- B4 4 A6
- B4 5 A5
- B4 6 nWE
- B4 7 D7
- B4 8 D6
- B4 9 D5
- B4 10 D4
- B4 11 D3
- B4 12 D2
- B4 13 D1
- B4 14 D0
- B4 15 SRAM_nCS
- B4 16 A4
- B4 17 A3
- B4 18 A2
- B4 19 A1
- B4 20 A0
- B3 6 A10
- B3 5 A11
- B3 2 A12
- B3 1 A13
- B4 36 A14
- B4 35 A18
- B4 34 D8
- B4 33 D9
- B4 32 D10
- B4 31 D11
- B4 30 D12
- B4 29 D13
- B4 21 A17
- B4 22 A16
- B4 23 A15
- B4 24 nOE

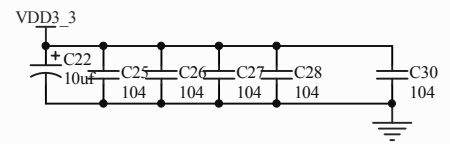
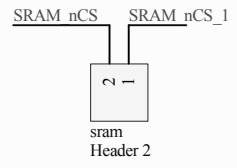

艾米电子工作室
<http://www.amy-studio.com/>
<http://shop33537127.taobao.com/>

Title		
Size	Number	Revision
A4		
Date:	2008-9-21	Sheet of
File:	E:\个人工作\08-board\NIOS\memory.SchDoc Drawn By:	

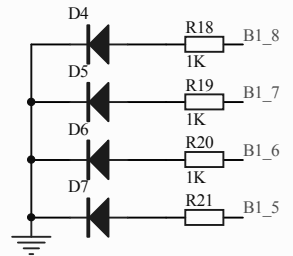

艾米电子工作室

<http://www.amy-studio.com/>

<http://shop33537127.taobao.com/>

Title		
Size A4	Number	Revision
Date:	2008-9-21	Sheet of
File:	E:\个人工作\08-board\NIOS\module.SchDoc Drawn By:	

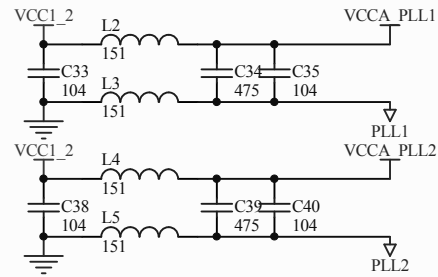
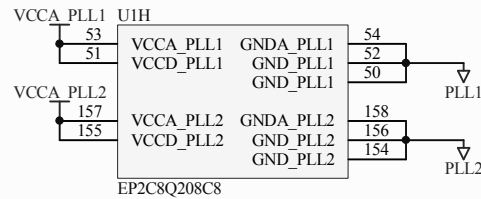
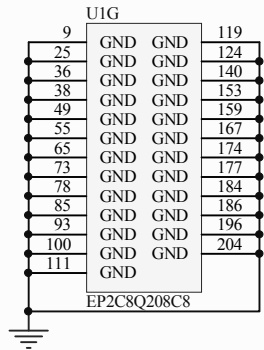
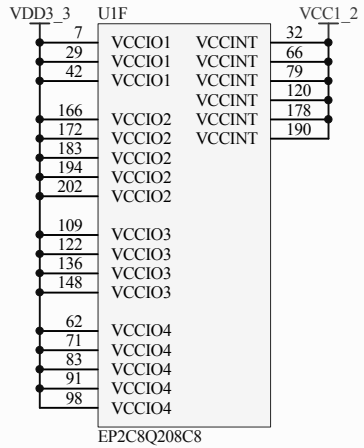
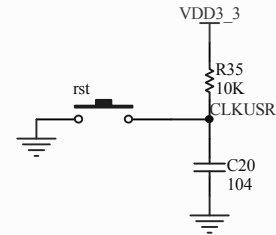
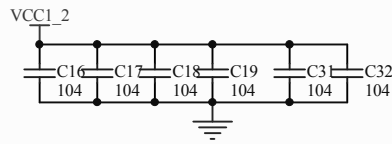
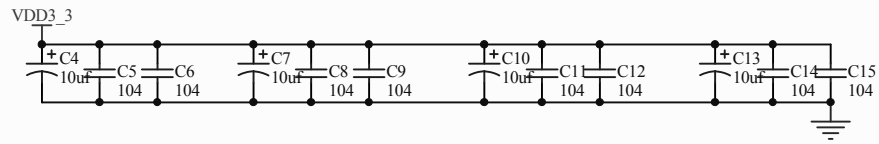

艾米电子工作室

<http://www.amy-studio.com/>

<http://shop33537127.taobao.com/>

这部分电容尽量靠近PLL脚

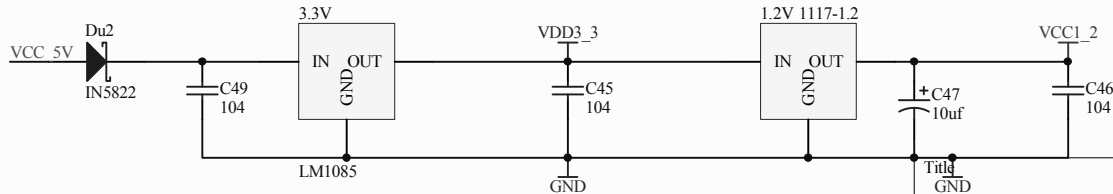
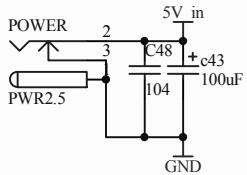
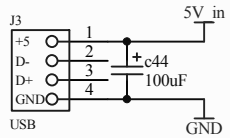
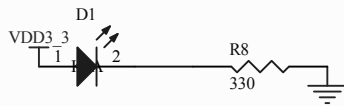
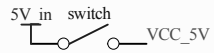

Size	Number	Revision
A4		
Date:	2008-9-21	Sheet of
File:	E:\个人工作\08-board\Nios\power.SchDoc Drawn By:	