

UM2455

M-Power500 Module User Manual

Application Note

AN-2455-06

The content of this technical document is subject to change without notice. Please contact UBEC for further information.

Version: 0.0
Released Date: 2009/02/10

All rights are strictly reserved. Any portion of this document shall not be reproduced, copied, or transformed to any other forms without prior permission from Uniband Electronic Corp.

UM2455**M-Power500 Module User Manual**

1. General Information

The M-Power500 module satisfies the requirements of low-power and long-range wireless sensor applications. It integrates UBEC's UM2455 2.4GHz transceiver with UBEC's RF front-end IC UP2268 to extend the transmitting and the receiving distance at low current consumption. Both the low current consumption and long distance capability are especially suitable for battery-limited applications. The module's flexible and reliable interface allows the users to develop configurations appropriate for their applications.

The M-Power500 module, derived from UBEC's M-stamp module, operates within the ISM 2.4 – 2.5 GHz frequency band and contains UBEC's UM2455, UP2268 and other necessary components such as crystal oscillator, inductors and capacitors. The transceiver within the UM2455 chip features a maximum of 5 MHz serial interface SPI bus for control and data transfer. It is a simple SPI interface slave device consisting of a 4-wire bus (SCLK, SI, SO, and SEN) that provide accesses to various subunits such as MAC/BB/RF control/status registers, TXFIFOs, RXFIFOs and security key table.

The UP2268 is an RF front-end IC integrating a high-efficiency, linear power amplifier (PA), a switch and a low noise amplifier (LNA). Its low current consumption and inherent power gain enable the designers to meet the challenges of the battery operation and long distance requirements demanded by many applications. In addition, the small module form factor (QFN3x3) saves the valuable board space.

2. Features

- ISM band 2.405~2.480 GHz operation
- 3.0~3.6V Operation
- Sleep Current: 3uA (typical)
- >500m Range (Environment dependent)
- Chip Antenna
- Receiver Sensitivity: -101dBm
- TX Power : 10dBm
- TX Current : 54mA
- RX Current : 26mA
- Size: 38.35mmx 14.00mm

Figure 1 shows the top view of a M-Power500 with a chip antenna. The PCB size is 38.35mm x 14.00 mm.

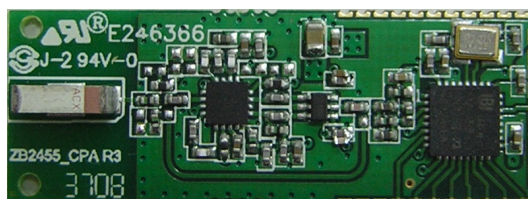

Figure 1. M-Power500 Module

3. Pin Configuration

UM2455 M-Power500 module pin assignments and their functions are described below.

Pin Number	Pin Name	Type	Description
1	NC	NC	NC
2	NC	NC	NC
3	NC	NC	NC
4	GPIO0	DIO	General purpose digital I/O, also used as an external PA enable
5	RESETN	DI	Global hardware reset pin, active low
6	WAKE	DI	External wake up trigger, active high / low can be programmable.
7	INT	DO	Interrupt pin to micro-processor : Level trigger, Hi / Low programmable
8	SO	DIO	Serial interface data output from UM2455 or I2C clock
9	SI	DIO	Serial interface data input to UM2455 or I2C data in/out
10	SCLK	DI	Serial interface clock
11	SEN	DI	Serial interface enable
12	NC	NC	NC
13	NC	NC	NC
14	NC	NC	NC
15	NC	NC	NC
16	CLKOUT	DIO	20/10/5/2.5 MHz Clock output
17	GND	Ground	Ground
18	VCC	Power	3V
19	VCC	Power	3V
20	GND	Ground	Ground
21~31	NC	NC	NC

UM2455 M-Power500 module pin names and pin number allocation map are shown in Figure 2. It can interface with other devices such as a sensor, an LED, a host controller, a push button, a joystick or power relays through GPIO signals.

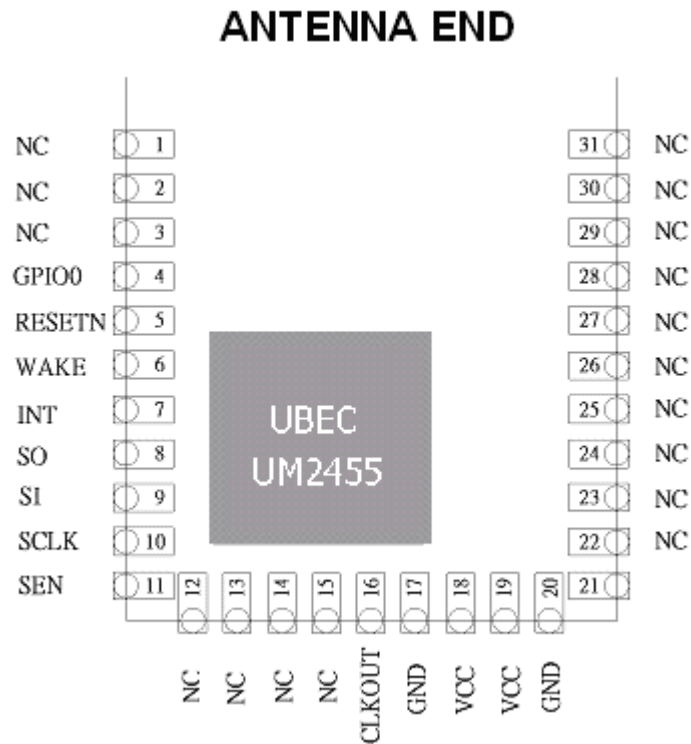

Figure 2. M-Power500 Module Pin Names and Location Map

4. Electrical Specifications

Item	Conditions	Specifications			Unit
		Min.	Typ.	Max.	
Frequency Range		2.405		2.480	GHz
Input Voltage		3.0		3.6	V
Current Consumption (TX)	3V, $P_{out}=10\text{dBm}$		54		mA
Current Consumption (RX)	3V,		26		mA
TX Output Power	3V, $P_{out}(\text{UM2455})=0\text{dBm}$		10		dBm
TX EVM	3V, $P_{out}(\text{UM2455})=0\text{dBm}$	10		18	%
RX Sensitivity	3V, PER \leq 5%		-100		dBm
Communication Range	3V, PER \leq 5%, LOS		500		m

For detailed functional descriptions and electrical characteristics of the UM2455 chip, please refer to UM2455 datasheet, DS-2455-01.

4.1. TX Output Power

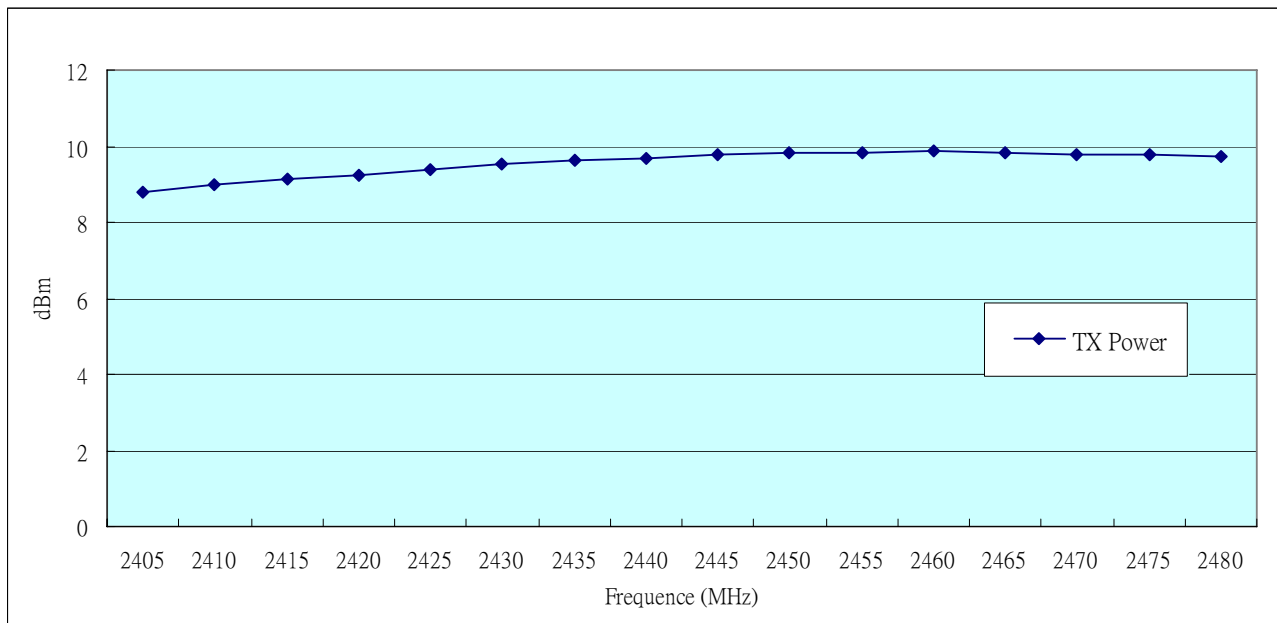

Figure 3. TX Output Power

4.2. TX EVM

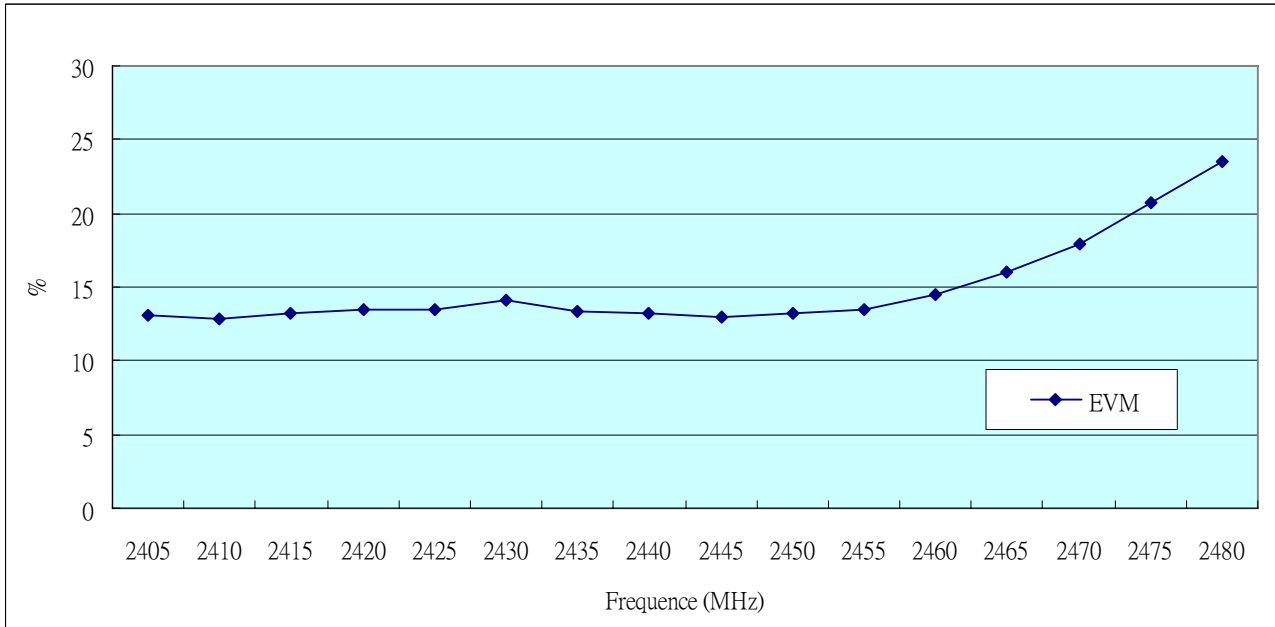

Figure 4. TX EVM

4.3. RX Sensitivity

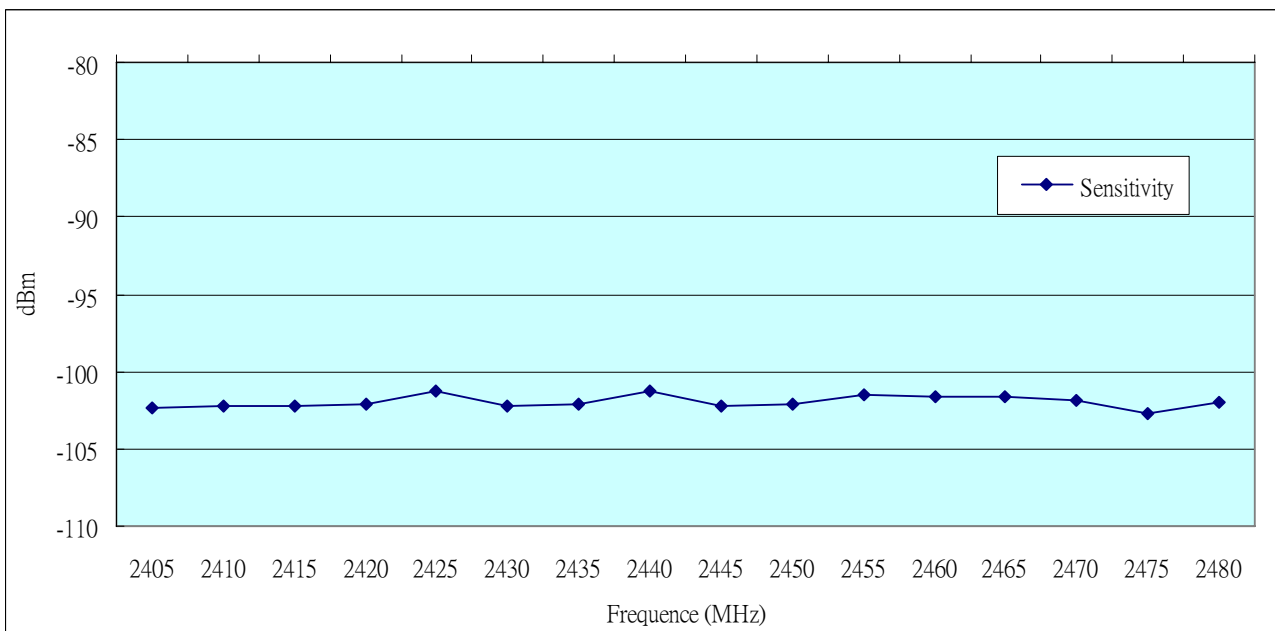
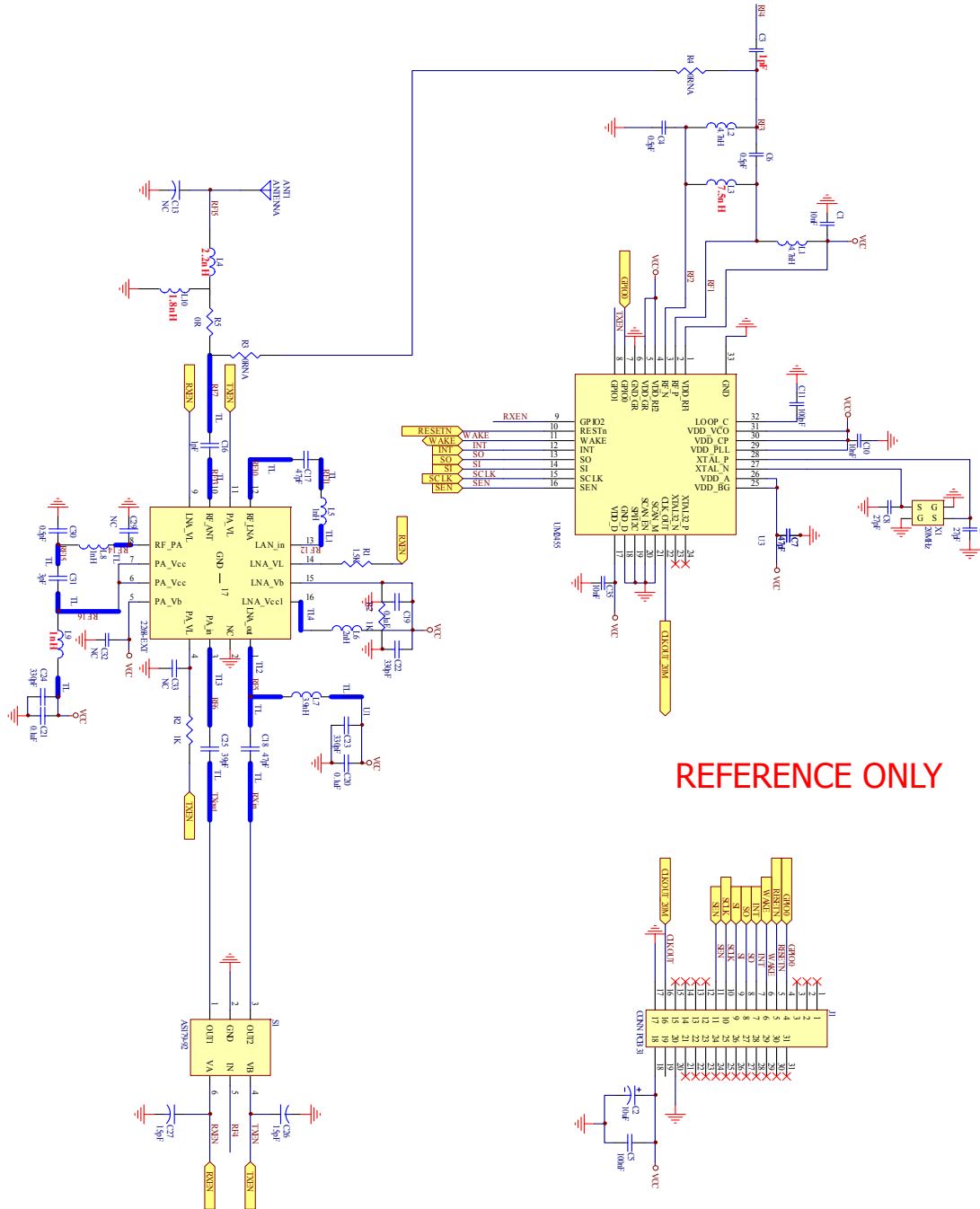

Figure 5. RX Sensitivity

5. Schematic

The schematic below is suitable for operation with a bias voltage between 3.0 and 3.6V. If a lower bias voltage between 2.7 and 3.0V is desired, certain resistors in this schematic have to be replaced. Please consult UBEC for further information.



6. Mechanical Dimension

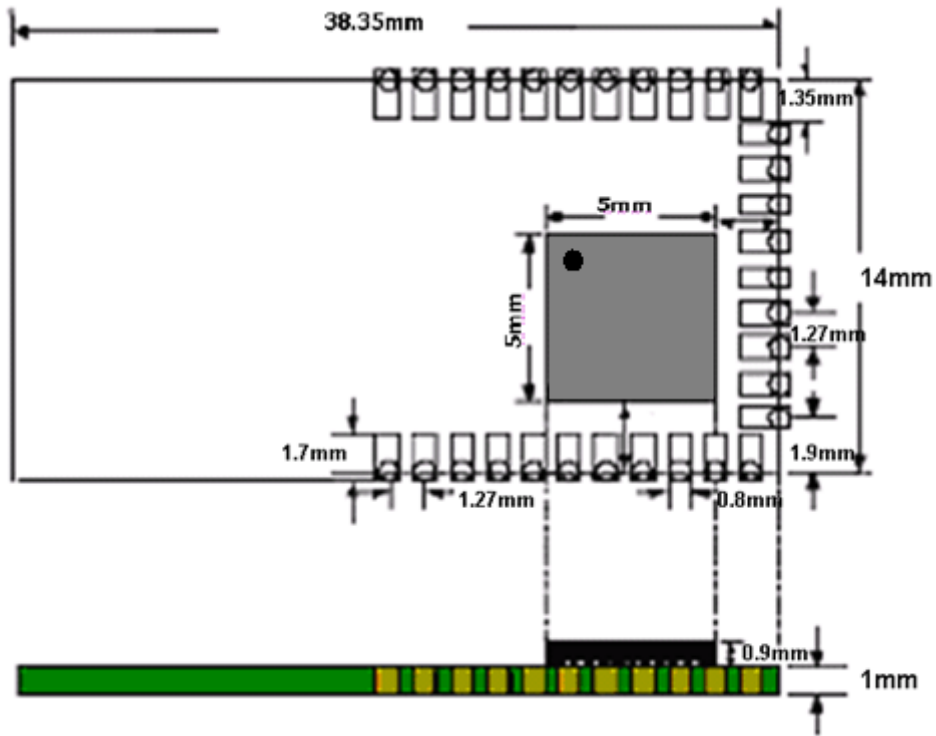

Figure 6. Module Dimensions

7. Antenna Topology

Notice:

- (1) Antenna should be put on the edge of the system.
- (2) Be sure that there is no obstacles (components and ground) in the radiation direction
- (3) Do not put any ground plane and/or circuit beneath the antenna region for the system boards.

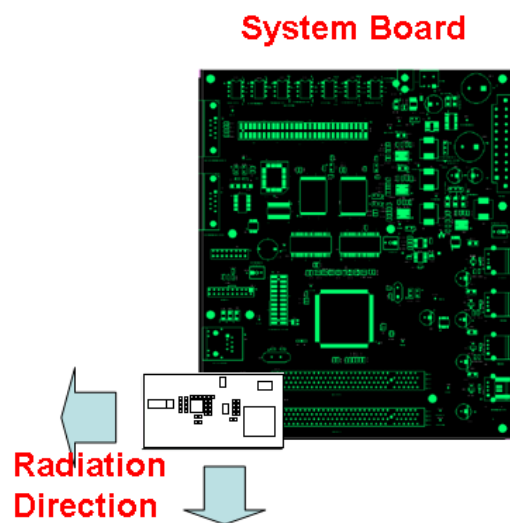

Figure 7. Recommended Antenna Location

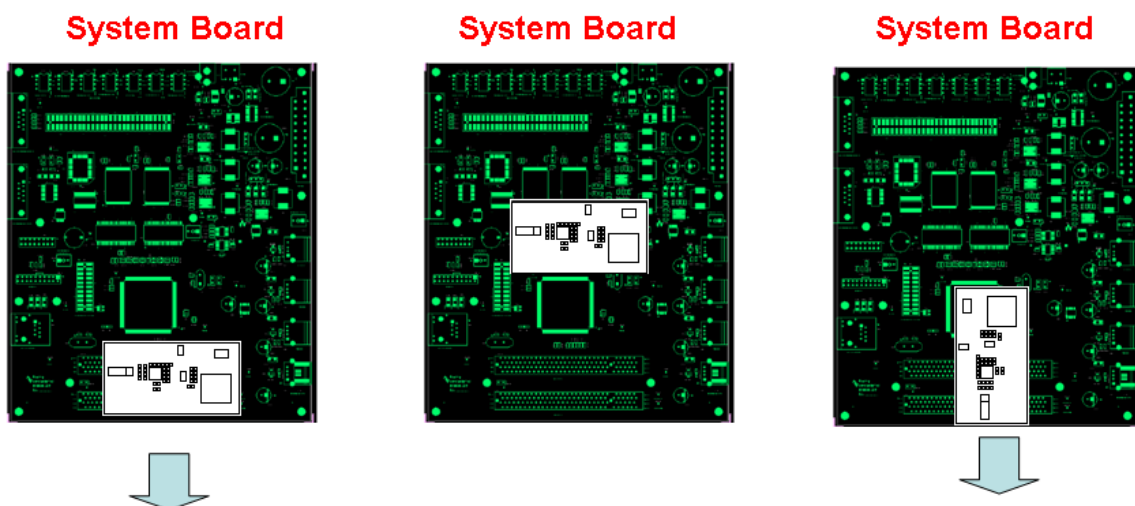

Figure 8. Example of Poor Antenna Locations

Revision History

Revision	Date	Description of Change
0.0	2009/02/10	Initial release

Contact UBEC:

Headquarters

Address: 6F-1, No. 192, Dongguang Rd., Hsinchu, 300 Taiwan

Tel: +886-3-5729898

Fax: +886-3-5718599

Website: <http://www.ubec.com.tw>

Sales Services

Tel: +886-3-5729898

Fax: +886-3-5718599

E-mail: sales@ubec.com.tw

FAE Services

Tel: +886-3-5729898

Fax: +886-3-5718599

E-mail: fae@ubec.com.tw

DISCLAIMER

ALTHOUGH TO THE BEST KNOWLEDGE OF THE UNIBAND ELECTRONIC CORPORATION (UBEC) THIS DOCUMENT IS ADEQUATE FOR ITS INTENDED PURPOSES, UBEC MAKES NO WARRANTY OF ANY KIND WITH REGARD TO ITS COMPLETENESS AND ACCURACY. UBEC EXPRESSLY DISCLAIMS ANY AND ALL OTHER WARRANTIES, WHETHER EXPRESSED, IMPLIED, OR STATUTORY INCLUDING WITHOUT LIMITATION WARRANTIES OF TITLE, MERCHANTABILITY, NON-INFRINGEMENT, AND FITNESS FOR A PARTICULAR PURPOSE, WHETHER ARISING IN LAW, CUSTOM, CONDUCT OR OTHERWISE.