

This datasheet is applicable to all revision 8I chips

QT1106 charge-transfer ('QT') QTtouch™ IC is a self-contained, patented charge-transfer capacitive controller capable of detecting near-proximity or touch on up to seven electrodes and a wheel/slider. It allows electrodes to project sense fields through any dielectric such as glass or plastic. These electrodes are laid out as a scroller (e.g. a wheel or slider) plus seven additional independent keys. Each key channel can be tuned for a unique sensitivity level by simply changing a corresponding external Cs capacitor, whereas the wheel/slider's sensitivity can be changed dynamically through SPI commands.

The wheel/slider uses a simple, inexpensive sensing element between three connection points. The QT1106 can report a single rapid touch anywhere along the sense elements, or it can track a finger moving along the wheel/slider's surface in real time.

By using the charge-transfer principle, this device delivers a level of performance clearly superior to older technologies yet is highly cost-effective. Spread-spectrum burst technology provides superior noise rejection

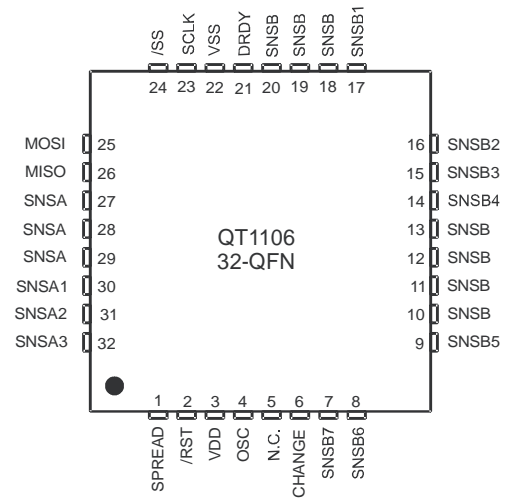

## AT A GLANCE

<b>Number of keys:</b>	0 to 7, one slider or one wheel
<b>Technology:</b>	Patented spread-spectrum charge-transfer
<b>Key outline sizes:</b>	5mm x 5mm or larger (panel thickness dependent); widely different sizes and shapes possible
<b>Key spacings:</b>	6mm or wider, center to center (panel thickness, human factors dependent)
<b>Key design:</b>	Single solid or ring shaped electrodes; wide variety of possible layouts
<b>Wheel size:</b>	Typically 30mm- 50mm diameter, resistored wheel up to 80mm diameter, typical width 12mm
<b>Slider size:</b>	Typically 50mm-100mm length, typical width 12mm
<b>Wheel electrode design:</b>	Resistorless/resistored design
<b>Slider electrode design:</b>	Resistorless/resistored design (can be an arc or other irregular shape)
<b>Layers required:</b>	One layer substrate; electrodes and components can be on same side
<b>Substrates:</b>	FR-4, low cost CEM-1 or FR-2 PCB materials; polyamide FPCB; PET films, glass
<b>Electrode materials:</b>	Copper, silver, carbon, ITO, Orgacon† ink (virtually anything electrically conductive)
<b>Panel materials:</b>	Plastic, glass, composites, painted surfaces (nonconductive paints)
<b>Adjacent Metal:</b>	Compatible with grounded metal immediately next to keys
<b>Key panel thickness:</b>	Up to 15mm glass, 10mm plastic (key size dependent)
<b>Wheel/Slider panel thickness:</b>	Up to 4mm glass, 3mm plastic
<b>Key sensitivity:</b>	Adjustable via change in sampling capacitor (Cs) value
<b>Outputs:</b>	SPI
<b>Moisture tolerance:</b>	Good
<b>Power:</b>	2.8V ~ 5.0V
<b>Package:</b>	32-pin 5 x 5mm QFN RoHS compliant
<b>Signal processing:</b>	Self-calibration, auto drift compensation, noise filtering, patented Adjacent Key Suppression™
<b>Applications:</b>	Portable devices, domestic appliances and A/V gear, PC peripherals, office equipment
<b>Patents:</b>	<b>AKS™</b> (patented Adjacent Key Suppression) <b>QTtouch™</b> (patented Charge-transfer method) <b>QWheel™/QSlide™</b> (patented Charge-transfer method) (patent-pending QWheel/QSlide sensing configuration)

†Orgacon is a registered trademark of Agfa-Gevaert N.V

### AVAILABLE OPTIONS

T <sub>A</sub>	32-QFN
-40°C to +85°C	QT1106-ISG

# Contents

<b>1 Overview</b>	3	<b>4 Operating Modes</b>	11
1.1 Introduction	3	4.1 Introduction	11
1.2 Burst Operation	3	4.2 Free Run Mode	11
1.3 User Interface Layout Options	3	4.3 LP Mode	11
1.4 Slider and Wheel Construction	3	4.4 Sleep Mode	12
1.5 QMagic™ Proximity Effect	3	4.5 Sync Mode	12
1.6 SPI Interface	3	<b>5 Reset</b>	13
1.7 Basic Power Modes	4	5.1 Introduction	13
1.7.1 Overview	4	5.2 Delay to SPI Functionality	13
1.7.2 Free Run Mode	4	5.3 Reset Delay to Touch Detection	13
1.7.3 LP Mode	4	5.4 Mode Setting After Reset	13
1.7.4 Sleep Mode	4	<b>6 Design Notes</b>	13
1.7.5 Sync Mode	4	6.1 Oscillator Frequency	13
<b>2 Signal Processing</b>	4	6.2 Spread-spectrum Circuit	13
2.1 Power-up Self-calibration	4	6.3 Cs Sample Capacitors - Sensitivity	13
2.2 Drift Compensation	4	6.4 Rsns Resistors	14
2.3 Detection Integrator Filter	4	6.5 Thermal Stability	14
2.4 AKSTM Adjacent Key Suppression	4	6.6 Power Supply	14
2.5 Autorecalibration (MOD)	4	6.7 PCB Layout and Construction	14
2.6 QMagic™ Proximity Sensor	5	<b>7 Specifications</b>	15
2.7 Faulty and Unused Keys	5	7.1 Absolute Maximum Specifications	15
2.8 Wiring	6	7.2 Recommended Operating Conditions	15
<b>3 SPI Interface</b>	8	7.3 AC Specifications	15
3.1 Introduction	8	7.4 DC Specifications	15
3.2 CHANGE Pin	8	7.5 Signal Processing	16
3.3 SPI Parameters	8	7.6 Idd Curves	17
3.4 SPI Operation	8	7.7 Mechanical Dimensions - 32-QFN Package	19
3.5 SPI Host Commands	9	7.8 Part Marking	19
3.5.1 Overview	9	7.9 Moisture Sensitivity Level (MSL)	20
3.5.2 Normal Command Mode	9	<b>8 Datasheet Control</b>	21
3.5.3 Custom Threshold Command Mode	10	8.1 Changes	21
3.6 SPI Responses	10	8.2 Numbering Convention	21

# 1 Overview

## 1.1 Introduction

The QT1106 is an easy to use sensor IC based on Quantum's patented charge-transfer ('QT') principles for robust operation and ease of design. This device has many advanced features which provide for reliable, trouble-free operation over the life of the product. In particular the QT1106 features advanced self-calibration, drift compensation, and fast thermal tracking. Unlike prior devices, the QT1106 can tolerate power supply fluctuations better in order to eliminate the need for a voltage regulator in many cases.

## 1.2 Burst Operation

The device operates in burst mode. Each key is acquired using a burst of charge-transfer sensing pulses whose count varies depending on the value of the sense capacitor Cs and the load capacitance Cx (finger touch capacitance and circuit stray capacitance).

The channels' signals are acquired using three successive bursts of pulses:

- Burst 1: B1, B3, B5, B7 (for discrete keys 1, 3, 5, 7)
- Burst 2: B2, B4, B6 (for discrete keys 2, 4, 6)
- Burst 3: A1, A2, A3 (for wheel or slider)

Bursts always operate in 1, 2, 3 sequence as a group and occur one right after the other with minimum delay. The groups are separated by an interval of time that can be used for SPI communications.

**Spread-spectrum operation** - Bursts can operate over a spread of frequencies, so that external fields will have minimal effect on key operation and emissions are very weak.

Spread-spectrum operation works together with the 'detect integrator' (DI) mechanism to dramatically reduce the probability of false detection due to noise. An external RC circuit is required to implement spread spectrum, but this circuit is optional.

## 1.3 User Interface Layout Options

The QT1106 can sense through all common plastics or glass or other dielectric materials up to 10mm thick. It can be used to implement a linear slider or rotary scroll wheel plus seven additional discrete keys. The slider or wheel indicates absolute positions.

## 1.4 Slider and Wheel Construction

The QT1106 can connect to either a wheel or a linear slider element (Figure 1.1). Selection of wheel or linear operation is set through an SPI command. The basis of these designs is found in US Patent 4,264,903 (expired).

The first and last positions of the linear slider have larger touch areas.

As with touch button electrodes, wheels and sliders can be constructed as etched areas on a PCB or flex circuit, or from clear conductors such as Indium Tin Oxide (ITO) or screen-printed Orgacon™ (Agfa) to allow backlighting effects, or for use over an LCD display.

## 1.5 QMagic™ Proximity Effect

Channel 7 of the QT1106 can optionally operate a 'magic on' function based on hand or body proximity to a product. By using a relatively large electrode inside the product's enclosure and a larger value of Csb7 (see Figure 2.1), the product can auto power up or activate its display with hand approach. This simple feature can add enormous sales appeal to almost any product.

## 1.6 SPI Interface

The QT1106 uses a five-wire SPI interface. In addition to the standard four SPI signals (/SS, SCLK, MOSI and MISO), there is a DRDY (data ready) output for flow control.

The QT1106 also provides a CHANGE signal to indicate when there has been a change in detection state. This removes the need for the host to poll the QT1106 continuously.

On each SPI transfer the host sends three bytes to the QT1106 and the QT1106 simultaneously sends three bytes to the host. The bytes sent from the host provide the QT1106 with all its configuration information; the bytes sent from the QT1106 convey the key states.

**Figure 1.1 All-Metal Slider and Wheel Construction**  
(downloadable example CAD files for wheels and sliders can be found on the Quantum website, <http://www.qprox.com/toolbox>, then click **QT1106**)

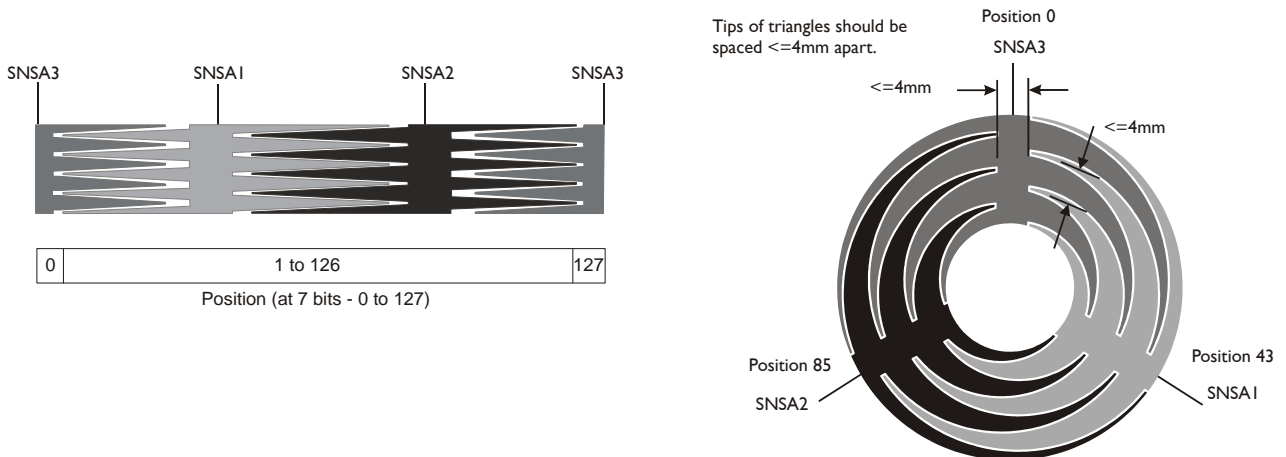

## 1.7 Basic Power Modes

### 1.7.1 Overview

The device features a number of modes to set the current drain and speed of response.

The available operating modes are:

- Free Run - fastest detection response at all times
- LP mode - low power, slower touch sensing response
- Sleep - microamp-level current drain
- Sync mode - for noise suppression of low frequencies

### 1.7.2 Free Run Mode

This mode uses a continuous stream of acquire bursts. Free Run mode has, in consequence, the highest power drain of all the QT1106 operating modes but the fastest response time.

### 1.7.3 LP Mode

In LP (low power) mode, the QT1106 spends most of the time sleeping to conserve power; it wakes itself periodically to perform acquire bursts, then normally goes back to sleep again.

The QT1106 provides a choice of intervals between acquire bursts to allow an appropriate speed/power trade-off to be made for each product.

### 1.7.4 Sleep Mode

In Sleep mode, the QT1106 shuts down to conserve power; it will remain in this mode forever or until the host wakes it using the /SS pin.

### 1.7.5 Sync Mode

In this mode the device will synchronize to the host in a way that allows for the suppression of heavy low frequency noise; for example, from mains frequencies and their harmonics.

## 2 Signal Processing

### 2.1 Power-up Self-calibration

On power-up or after reset, all 10 channels are typically calibrated and operational within 650ms.

### 2.2 Drift Compensation

This operates to correct the reference level of each key automatically over time; it suppresses false detections caused by changes in temperature, humidity, dirt and other environmental effects.

### 2.3 Detection Integrator Filter

Detect Integrator (DI) filter confirmation reduces the effects of noise on key states. The DI mechanism requires a specified number of measurements that qualify as detections (and these must occur in a row) or the detection will not be reported.

In a similar manner, the end of a touch (loss of signal) also has to be confirmed over several measurements. The QT1106 provides a choice of either two or six DI measurements for confirming start of touch; end of touch always uses two measurements.

The DI mechanism works together with spread spectrum operation to dramatically reduce the effects of noise.

## 2.4 AKS™ Adjacent Key Suppression

This patented feature works to prevent multiple keys from responding to a single touch. This can happen with closely spaced keys, or a scroll wheel that has buttons very near it.

AKS operates by comparing signal strengths from keys within a group of keys to suppress touch detections from those that have a weaker signal change than the dominant one.

When enabled globally on the QT1106, AKS allows only one independent key, or the scroll section, to indicate a touch at a time. Additionally, the QT1106 has options for partial AKS; where some keys are included in the AKS operation and others are not affected. In this case only one key in the AKS group can indicate a touch at any time; other keys can indicate touch in any combination.

AKS can also be disabled.

## 2.5 Autorecalibration (MOD)

The device can time out and recalibrate each key independently after a continuous touch detection that lasts for the chosen 'Maximum on-duration' (MOD). This ensures that a key can never become 'stuck on' due to foreign objects or other external influences.

After recalibration the key will continue to function normally. The nominal delay is selectable to be either 10s, 20s, 60s, or infinite (disabled), though the actual delay is different in some operating modes (see Table 2.1).

Table 2.1 Maximum On-duration

Operating Mode	Max on-durations
Free Run	10s, 20s, 60s
LP mode, 200ms <sup>1</sup> response (120ms <sup>2</sup> )	10s, 20s, 60s
LP mode, 280ms <sup>1</sup> response (200ms <sup>2</sup> )	10s, 20s, 60s
LP mode, 440ms <sup>1</sup> response (360ms <sup>2</sup> )	15s, 30s, 88s
LP mode, 760ms <sup>1</sup> response (680ms <sup>2</sup> )	28s, 55s, 164s
Sync mode (typ 55Hz sync)	10s, 20s, 60s (vary with sync rate)
Sleep mode	n/a

<sup>1</sup> response times are estimated using a DI of six counts.

<sup>2</sup> response times are estimated using a DI of two counts.

**Note:** all response times are based on typical sense capacitor values.

The device also autorecalibrates all keys when one or more normal keys' signal reflect a sufficient decrease in capacitance from the reference level (signal error). If QMagic Proximity mode is active, a signal error on the Proximity Key (Key 7) will only recalibrate itself. This is filtered in a manner similar to the DI filter; the decrease in capacitance must be seen for at least six successive cycles. Hence, in Free Run mode the device typically recalibrates within 400ms so as to recover normal operation quickly.

## 2.6 QMagic™ Proximity Sensor

Key 7 (SNSB7) can be optimized for operation as a hand proximity sensor via the serial interface (see Section 3.5.2, Prox = 1). The proximity sensitivity of channel 7 can be increased by a higher value of Cs. The AKS mode should be set to mode 101, to ensure that the proximity key does not lock out other keys or the wheel/slider.

Note that proximity fields are often unstable especially in products that can move around, such as mobile phones and MP3 players. In particular, the proximity channel can stick on after a detection. As soon as possible after proximity channel 7 becomes active, it should be recalibrated via the serial interface (see Section 3.5.2, CalK = 1, Cal Key Num bits = 111) in order to clear the proximity channel.

Design of proximity electrodes requires care, so as to ensure that the electrode area is maximized whilst ensuring adequate and easy coupling to a hand as it approaches the equipment.

## 2.7 Faulty and Unused Keys

Any sense channel that does not have its sense capacitor (Cs) fitted is assumed to be either faulty or unused. This channel takes no further part in operation unless a host-commanded recalibration operation shows it to have an in-range burst count again.

This is important for sense channels that have an open or short circuit fault across Cs. Such channels would otherwise cause very long acquire bursts, and in consequence would slow the operation of the entire QT1106.

## 2.8 Wiring

Table 2.2 Pinlist

32-QFN Pin	Name	Type	Function	Notes	If Unused
1	SPREAD	OD	Spread-spectrum drive	-	Open
2	/RST	I	Reset input	Active low reset	Vdd
3	Vdd	P	Power	+2.8 to +5.0V	-
4	OSC	I	Oscillator current drive	Resistor to Vdd and optional spread-spectrum RC network	-
5	n/c	-	-	Leave open	-
6	CHANGE	OF	State change notification	To host	-
7	SNSB7	I/O	To Csb7	Sense pin	Open
8	SNSB6	I/O	To Csb6	Sense pin	Open
9	SNSB5	I/O	To Csb5	Sense pin	Open
10	SNSB	I/O	To any Csb + Key	Sense pin	Open
11	SNSB	I/O	To any Csb + Key	Sense pin	Open
12	SNSB	I/O	To any Csb + Key	Sense pin	Open
13	SNSB	I/O	To any Csb + Key	Sense pin	Open
14	SNSB4	I/O	To Csb4	Sense pin	Open
15	SNSB3	I/O	To Csb3	Sense pin	Open
16	SNSB2	I/O	To Csb2	Sense pin	Open
17	SNSB1	I/O	To Csb1	Sense pin	Open
18	SNSB	I/O	To any Csb + Key	Sense pin	Open
19	SNSB	I/O	To any Csb + Key	Sense pin	Open
20	SNSB	I/O	To any Csb + Key	Sense pin	Open
21	DRDY	OF	SPI Data Ready	SPI handshake line	-
22	Vss	P	Ground	-	-
23	SCLK	I	SPI Clock	SPI serial bit clock	-
24	/SS	I	SPI Slave Select in	Idle high, slave select line	-
25	MOSI	I	SPI Master Out /Slave In	Data from host to QT1106	-
26	MISO	OF	SPI Master In / Serial Out	Data from QT1106 to host	-
27	SNSA	I/O	To any Csa + wheel/slider	Sense pin	Open
28	SNSA	I/O	To any Csa + wheel/slider	Sense pin	Open
29	SNSA	I/O	To any Csa + wheel/slider	Sense pin	Open
30	SNSA1	I/O	To Csa1	Sense pin position 43	Open
31	SNSA2	I/O	To Csa2	Sense pin position 85	Open
32	SNSA3	I/O	To Csa3	Sense pin position 0	Open

### Pin Type

I/O	CMOS input/output
I	CMOS input only
OD	CMOS open drain output (pull up to Vdd)
OF	CMOS output that can float during Reset, Sleep or LP modes
P	Ground or power

**Note:** Sense terminals can be twinned with any sense drive terminals of the same group, e.g. SNSA1 can be paired with any SNSA terminal.

Suggested regulator manufacturers:

- Toko (XC6215 series)
- Seiko (S817 series)
- BCDSemi (AP2121 series)

Re Figure 2.1 check the following sections for the variable component values:

- Section 6.3, page 13: Cs capacitors (Csb)
- Section 6.4, page 14: Sample resistors (RSNS)
- Section 6.6, page 14: Voltage levels
- Page 7: C<sub>SS</sub> capacitor

**Figure 2.1 Connection Diagram (32-QFN Package)**

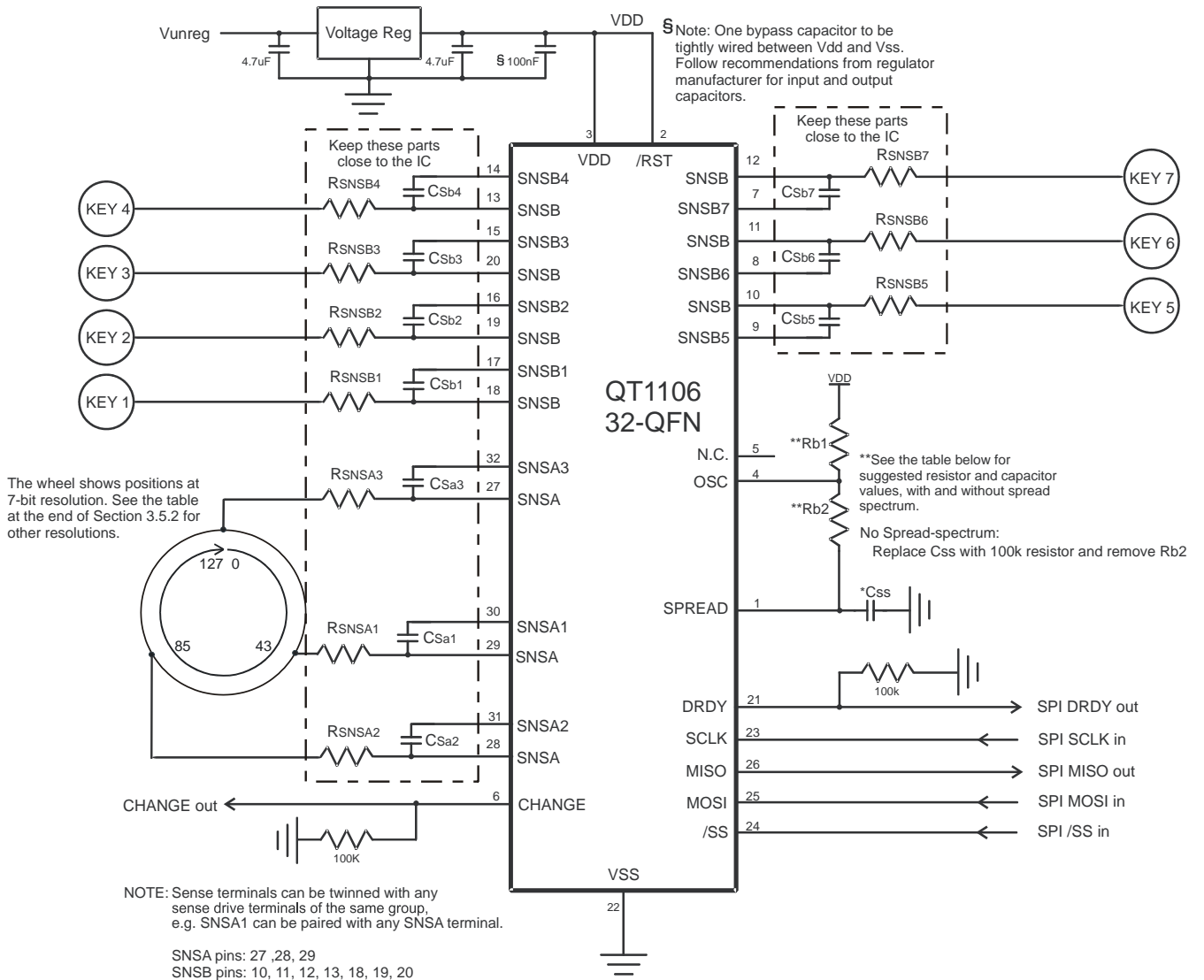

**IMPORTANT DESIGN GUIDELINES:**

- The sensitivities of the various sense channels are determined by the values of the respective Cs capacitors (i.e. Csb1, Csb7, etc.); these values will require adjustment based on building a prototype product and testing the sensitivity experimentally.
- Rb1, Rb2 sets the oscillator frequency; recommended values are:

Vdd Range	With Spread Spectrum			Without Spread Spectrum		
	Rb1	Rb2	Css	Rb1	Rb2	Css
< 3 V	12k	27k	see note below	15k	not fitted	replace with 100k resistor
3.0~3.6V	12k	22k		18k		
> 3.6V	15k	27k		20k		

- The required value of the spread-spectrum capacitor (C<sub>ss</sub>) will vary according to the lengths of the acquire bursts. A typical value is 100nF-220nF.
- When the QT1106 is running the OSC pin has a DC voltage typically between 1V and 1.5V; the use of spread spectrum will cause a small low-frequency variation in the voltage. The internal oscillator signal is not visible on this pin.
- Signals DRDY and CHANGE may need pull-down resistors, see Section 5 on page 13.



### 3 SPI Interface

#### 3.1 Introduction

The QT1106 is an SPI slave mode device. This section describes the hardware operation of this interface.

#### 3.2 CHANGE Pin

The QT1106 has a CHANGE output pin which allows for key state change notification. Use of the CHANGE signal relieves the host of the burden of regularly polling the QT1106 to get key states. CHANGE goes high when there is a change of state, i.e. when a new key is pressed, or released, or a movement is detected on the wheel/slider.

CHANGE also goes high after a reset to indicate to the host that it should do an SPI transfer in order to provide initial configuration information to the QT1106 (as it does on every SPI transfer).

CHANGE goes low after the status is read through an SPI transfer.

#### 3.3 SPI Parameters

The SPI transmission parameters are:

- 70kHz max clock rate
- 8 data bits
- 6.7µs min low clock period
- 6.7µs min high clock period
- Three bytes per transmission, byte 1 most significant bit sent first
- Clock idle high
- Shift out on falling edge
- Shift in on rising edge

The host must always transfer three bytes in succession within the allotted time (10ms maximum). If all bytes are not received in this interval it is treated by the QT1106 as an error and the DRDY line will go low before the transmission is completed.

Messages from the host to the QT1106 carry configuration information; return data from the QT1106 carries key state information. For details of the message contents see Sections 3.5 and 3.6.

#### 3.4 SPI Operation

The basic timing diagram for SPI operation is shown in Figure 3.1. The host does the clocking and controls the timing of the transfers, subject to Data Ready (DRDY), from the QT1106. Transfers are always clocked as a set of three bytes, Byte 1, 2 and 3.

The host should not attempt to clock the SPI bus to the device while DRDY is low; during DRDY low the QT1106 is busy and will ignore SPI activity, with the exception of a 20µs grace period after the fall of DRDY, where there are no communications during the high period of DRDY.

**Note:** DRDY can only become active (go high) if /SS is held high when idle.

DRDY stays high for at least 450µs. It falls again after Byte 3 has shifted to indicate completion. After the fall of DRDY, the device acquires (bursts). DRDY goes high to permit SPI activity after each burst.

After the host asserts /SS low, it should wait >22µs before starting SCLK. The QT1106 reads the MOSI pin with each rising edge of SCLK, and shifts data out on the MISO pin on falling edges. The host should do the same to ensure proper operation.

Between the end of the Byte 1 shift and the start of the Byte 2 shift (and between Byte 2 and Byte 3), the host may raise /SS again, but this is not required; the QT1106 ignores /SS during transfer of the three bytes.

All timings not mentioned above should be as in Figure 3.1.

Figure 3.1 SPI Operation

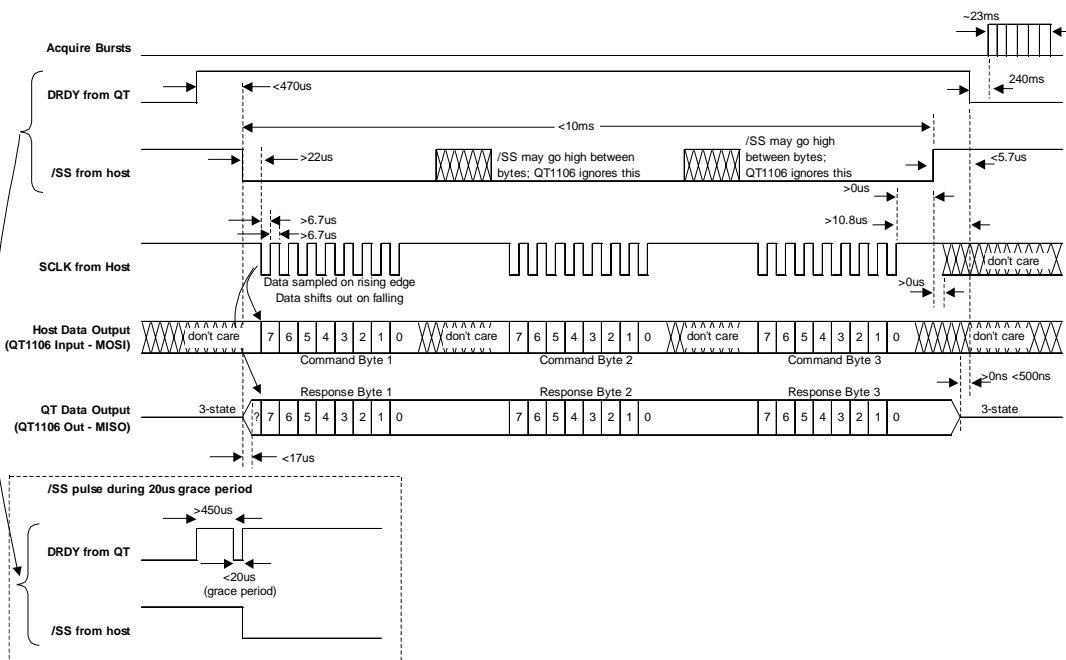



**/SS Wake Operation:** /SS is also used to wake the device from sleep, see Section 4.3

### 3.5 SPI Host Commands

#### 3.5.1 Overview

The command from the host consists of three bytes, #1, #2 and #3. These three bytes contain operation mode settings which must be transmitted every time. The setting information in these three bytes becomes effective immediately after all three are received by the QT1106.

The response to these three bytes are three data bytes containing key detection information.

A downloadable host-driver software example for controlling the QT1106 can be found on the Quantum website at <http://www.qprox.com/toolbox>, then click QT1106.

There are two command modes, selectable through bit **CT**.

**CT - Custom threshold:** Selects between normal command bytes and custom threshold commands.

**CT = 0:** Normal commands.

**CT = 1:** Custom Threshold commands.

#### 3.5.2 Normal Command Mode

When **CT = 0**, the three host command bytes should contain the following bits:

Host Byte #	Bit							
	7	6	5	4	3	2	1	0
1	CT=0	0	0	Prox	SLD	AKS		
2	0	MOD		DI	LPB	Mode		
3	Resolution			CalW	CalK	Cal Key Num		

Bits labelled '0' should not be altered.

The bits used in these three bytes are defined as follows:

**AKS** - Three bits used to determine the AKS mode. See Section 2.4 for further information.

AKS			AKS Option
2	1	0	
0	0	0	AKS disabled ( <b>default</b> )
0	0	1	AKS global
0	1	0	AKS keys + Wheel/Slider
0	1	1	AKS 4 keys <sup>1</sup> + 3 Keys <sup>2</sup> + Wheel/Slider
1	0	0	AKS 4 keys <sup>1</sup> + (3 Keys <sup>2</sup> + Wheel/Slider)
1	0	1	AKS (6 keys <sup>3</sup> + Wheel/Slider) + key 7

<sup>1</sup> keys 1-4 AKS'd together

<sup>2</sup> keys 5-7 AKS'd together

<sup>3</sup> keys 1-6 AKS'd together

**SLD** - Scrolling device type selection.

**SLD = 0:** Wheel mode (**default**)

**SLD = 1:** Linear slider mode.

**Prox** - Key 7 QMagic Proximity mode. See Section 2.6 for further information.

**Prox = 0:** Key 7 is a normal key (**default**)

**Prox = 1:** Key 7 is a proximity sensor.

**Note:** Once activated, Key 7 will be in QMagic Proximity mode until a reset occurs.

**Mode** - These bits determine the Sleep / Low Power modes the device runs in.

Mode Bits			Operating Mode
2	1	0	
0	0	0	Free Run ( <b>default</b> )
0	0	1	LP mode, 200ms <sup>1</sup> response time (120ms <sup>2</sup> )
0	1	0	LP mode, 280ms <sup>1</sup> response time (200ms <sup>2</sup> )
0	1	1	LP mode, 440ms <sup>1</sup> response time (360ms <sup>2</sup> )
1	0	0	LP mode, 760ms <sup>1</sup> response time (680ms <sup>2</sup> )
1	0	1	Sync mode
1	1	0	Sleep
1	1	1	(reserved)

<sup>1</sup> response times are estimated using a DI of six counts.

<sup>2</sup> response times are estimated using a DI of two counts.

**LPB** - Sets the LP mode 'following burst' option. See Figures 4.1 and 4.2.

**LPB = 0:** If the host communicates with the device or there is an /SS pulse during any LP mode (modes 001 to 100), there will be no following burst. The only bursts that will take place are those that occur as naturally defined by the LP mode noted above.

**LPB = 1:** If the host communicates with the device or there is an /SS pulse during any LP mode (modes 001 to 100), there will be an additional burst following /SS raising high. (**default**)

**DI** - Set the 'Detect Integrator' noise filter function.

**DI = 0:** Two detections required to confirm a touch (faster but less noise immune).

**DI = 1:** Six detections required to confirm a touch (slower but more noise immune; appropriate for most applications). (**default**)

**MOD (Recal Time)** - Sets the 'Maximum On-duration' for all keys. Controls the time from the start of a key detection to when the key is automatically recalibrated. See Table 2.1 for MOD times in other operating modes.

MOD		Maximum On-duration in Free Run Mode
6	5	
0	0	10s ( <b>default</b> )
0	1	20s
1	0	60s
1	1	infinite MOD - timeout disabled

**Cal Key Num** - key to be recalibrated when **CalK = 1**.

Cal Key Num Bits			Key
2	1	0	
0	0	0	Recalibrate all keys (excluding wheel/slider)
0	0	1	Recalibrate Key 1
0	1	0	Recalibrate Key 2
0	1	1	Recalibrate Key 3
1	0	0	Recalibrate Key 4
1	0	1	Recalibrate Key 5
1	1	0	Recalibrate Key 6
1	1	1	Recalibrate Key 7

**CalK** - Recalibrates the key(s) specified by **Cal Key Num**.

**CalK = 0:** No recalibration (normal state of this bit).

**CalK = 1:** The device recalibrates key(s).

**CalW** - Recalibrates the wheel/slider.

**CalW = 0:** No recalibration (normal state of this bit).

**CalW = 1:** The device recalibrates the wheel/slider.

Set CalK/CalW only once when required, and set CalK/CalW = 0 thereafter. If the bit is constantly set to 1, the device will keep recalibrating and will become non-responsive.

Note that the device recalibrates automatically on power-up, so that the use of Recal should rarely be required excepting Key 7 when used as a proximity sensor, in which case this channel should be recalibrated soon after each proximity detection to ensure stability.

**Resolution** - the resolution of the wheel/slider's reported position. Refer to Figure 3.2.

Resolution Bits			Resolution
7	6	5	
0	0	0	Reserved
0	0	1	2 Bits : 4 positions (0...3)
0	1	0	3 Bits : 8 positions (0...7)
0	1	1	4 Bits : 16 positions (0...15)
1	0	0	5 Bits : 32 positions (0...31)
1	0	1	6 Bits : 64 positions (0...63)
1	1	0	7 Bits : 128 positions (0...127) (default)
1	1	1	8 Bits : 256 positions (0...255)

**Note:** a resolution change will only become effective on the next touch.

### 3.5.3 Custom Threshold Command Mode

When **CT = 1**, the three host command bytes should contain the following bits:

Host Byte #	Bit							
	7	6	5	4	3	2	1	0
1	CT=1	0	0	0	0	0	0	0
2	T1 - Wheel/Slider Threshold							
3	0	0	0	0	0	0	0	0

**T1:** Custom threshold value of the wheel/slider. Higher numbers are less sensitive. Touch detection uses this threshold combined with a hysteresis equal to 12.5 percent of the threshold (with a minimum hysteresis value of one).  
**Power-up default setting: 40**

**Note:** Custom Threshold Command is only used if the detection threshold of the wheel/slider needs to be changed from the power-up default.

## 3.6 SPI Responses

The 3 return bytes which contain key states are as follows:

Return byte #	Bit							
	7	6	5	4	3	2	1	0
1	CW	CK	EW	EK	LPS	QM	0	CTL
2	W	K7	K6	K5	K4	K3	K2	K1
3	Position							

**CTL: Custom Threshold Loaded:** If CTL = 1, a custom wheel/slider threshold has been loaded from the host. If a custom threshold is utilised, **CTL** can be used to indicate if the threshold needs to be resent due to a reset of the device.

**QM: QMagic Proximity Mode:** If QM = 1, QMagic Proximity mode is activated (see Section 2.6).

**LPS: LP / Sleep State:** If LPS = 1, the device was in LP, Sync, or Sleep mode when the requesting command was received. If LPS = 0, the device was in Free Run mode.

**EK: Key(s) in Error:** If EK = 1, there is a sufficient decrease in capacitance of one or more normal key(s) from the reference level. All keys will be recalibrated if this condition is seen for six successive cycles. If QMagic Proximity mode is active, an error on the Proximity Key (Key 7) will only cause a recalibration on itself.

**EW: Wheel/Slider in Error:** If EW = 1, there is a sufficient decrease in capacitance of the wheel/slider from the reference level. The wheel/slider will be recalibrated if this condition is seen for six successive cycles.

**CK: Key(s) in Calibration:** If CK = 1, one or more key(s) are being calibrated.

**CW: Wheel/Slider in Calibration:** If CW = 1, the wheel/slider is being calibrated.

**Figure 3.2 Wheel and Slider Resolution**  
(see end of Section 3.5.2)

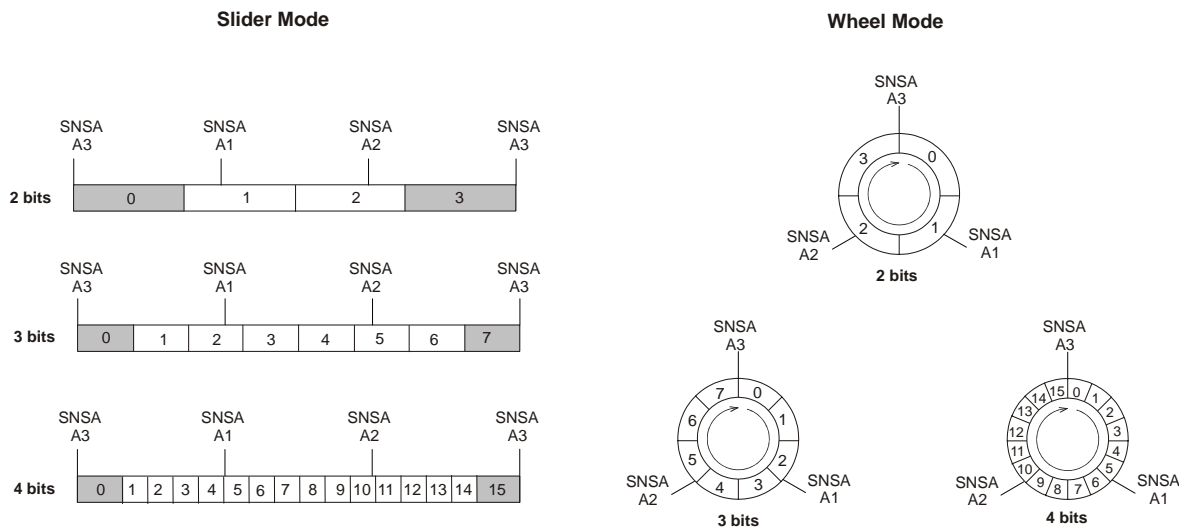

**Note:** the first and last slider positions (shaded) have larger touch areas.

**K1...K7:** Contains the key states of each key. A '1' in a bit position means the key is confirmed as being touched.

**W:** The state of the wheel/rotor. A '1' means the wheel/slider is confirmed as being touched.

**Position:** The position of touch on the wheel/slider. If the wheel/slider is not being touched, the position will be the position of the last touch.

## 4 Operating Modes

### 4.1 Introduction

Four basic operating modes are possible: Free Run, LP (Low Power), Sync and Sleep. Sleep is a special case of LP mode, where the sleep time is infinite. Sync is a special case of LP mode which acts as a noise filter over successive /SS pulses rather than temporarily operating as in Free Run mode.

### 4.2 Free Run Mode

In this mode the device operates continuously with short intervals between burst groups; there are three bursts, one burst for each electrode group. Between burst sets, DRDY goes high for 450µs to allow SPI communications.

In this mode, the acquisition bursts are unsynchronized, making this mode unsuitable if synchronization to mains frequency is needed.

### 4.3 LP Mode

LP mode is designed to allow low power operation while still retaining basic operation but at a slower speed. This mode is useful for devices that must use the touch keys to wake up a product, yet be in a low power mode.

Several LP timings allow the user to trade power versus response time: the slower the response time, the lower the power consumed.

In LP mode, the device spends most of the time sleeping between bursts; it wakes itself periodically to do a set of three acquisition bursts, then goes back to sleep.

If a touch is detected, the device operates as in Free Run mode and attempts to perform the DI (detect integrator noise filter) function to completion; if the DI filter fails to confirm a detection the device goes back to sleep and resumes LP mode. During the DI function the LPS bit will be cleared.

If a key is found to be in detection the CHANGE pin will go high and the part will remain in Free Run mode. To go back into LP mode the host has to request LP mode again.

**CHANGE Pin in LP Mode:** During the sleep portion of LP mode, CHANGE is held low.

If however a change of key state is confirmed, CHANGE goes high and the part runs from then on in Free Run mode until the host reads the key state and puts the device back into LP mode or some other mode.

**MISO in LP Mode:** During the sleep portion of LP mode, MISO floats.

**DRDY during LP Mode:** DRDY remains high while the QT1106 is sleeping, to indicate to the host that SPI communications are possible. In LP mode, the host should wake the QT1106 using a pulse on /SS before transferring data over SPI (see below). During an actual acquire burst, DRDY is held low.

**/SS Wake Pulse in LP Mode:** In LP mode the host should wake the device from sleep using a low pulse on /SS. The pulse should be at least 125µs wide.

Within 100µs of the end of the /SS pulse, the QT1106 will take DRDY low for at least 40µs to indicate that it has received the /SS wake pulse.

Following the >45µs DRDY low pulse, the host can communicate normally with the device (see 'Command During LP Mode' on Page 12).

If the LPB bit (page 9) is set, the device will then perform a set of acquire bursts during which DRDY will be low. Provided no key is detected as being touched during that burst, the QT1106 will go back to sleep, leaving DRDY high.

The CHANGE pin can go high if a key state changes during the burst(s) following the wake pulse.

If a key is confirmed as touched, the device will transition to Free Run mode automatically.

Figure 4.1 LP Mode SPI Operation with LPB = 1

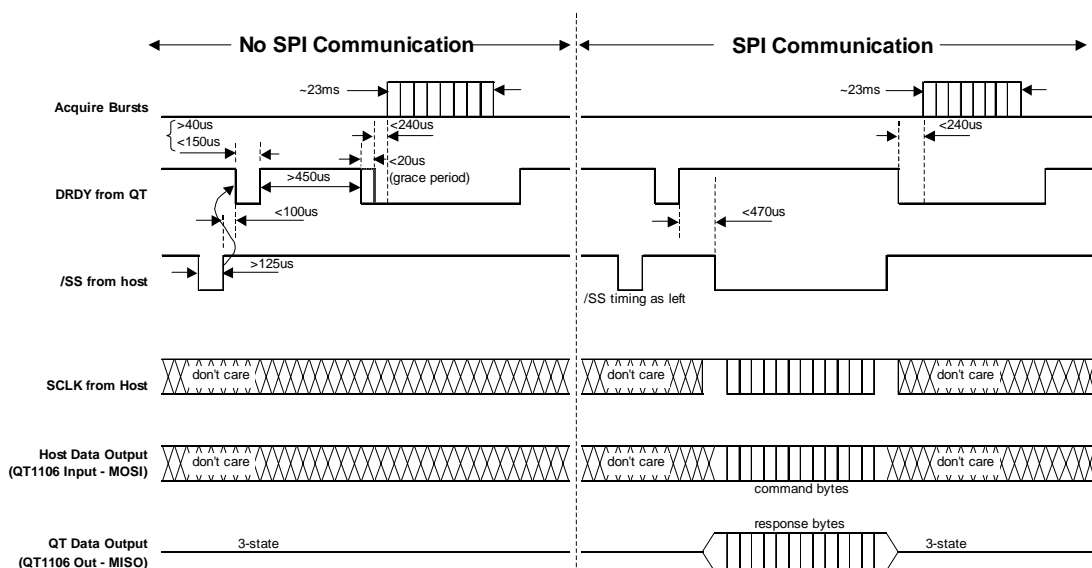

**Command During LP Mode:** First read '/SS Wake Pulse in LP Mode', on Page 11. Following DRDY rising at the end of the 45µs low pulse, the host may perform a normal SPI transfer as shown in Figure 3.1. The SPI transfer may start while DRDY is high (450µs), and for a 20µs grace period thereafter.

After the SPI transfer is completed, the QT1106 will generate a set of three acquire bursts if LPB = 1, during which DRDY will be low.

The mode and options settings sent from the host to the QT1106 during the SPI transfer take effect after the set of acquire bursts.

- If Free Run mode is selected, the QT1106 will take DRDY high to indicate the possibility of an SPI transfer.
- If either LP mode or Sleep mode is selected, the QT1106 will go back to sleep with DRDY high provided no key is detected as possibly touched.
- If Sync mode is selected, the QT1106 will go back to sleep with DRDY high provided no key is detected as possibly touched.

The CHANGE pin will go high at this time if a key is confirmed as touched.

#### 4.4 Sleep Mode

Sleep mode offers the lowest possible current drain, in the low microamp region.

Sleep mode is a special case of LP mode, where the sleep duration between bursts is infinite. All comments concerning LP mode, including about SPI communications, apply equally to Sleep mode, except that the LPB bit is ignored and bursts are always generated after an SPI transfer or /SS wake pulse as if LPB = 1.

Note that in Sleep mode the QT1106 only performs acquisition bursts following being woken by /SS. This has two effects.

- Touch detection only occurs following /SS-wake pulses, and hence CHANGE can only go high at that time.
- The QT1106 cannot drift its internal references unless the host sends periodic /SS wake pulses. If the host does not do this, then it should command the QT1106 to recalibrate when it sets the QT1106 into a different operating mode.

This mode can be used by the host to create its own 'LP Mode' timings via the /SS wakeup pulse method.

#### 4.5 Sync Mode

This mode is useful for low frequency noise suppression, for example from mains frequencies in line-operated appliances. Acquisition bursts are synchronized to the /SS-wake pulses from the host.

Sync mode is very similar to 'LP 760ms response time' mode, with two differences:

- It does not operate as in Free Run mode when a touch is first detected
- The LPB bit is ignored and a burst is always generated after each /SS wakeup or SPI transfer as if LPB = 1

Not operating as in Free Run mode when a touch is first detected (before DI confirmation has taken place) means that acquisition bursts are restricted to the immediate time after a sync signal (/SS), heightening the effect of low frequency noise suppression.

In many applications of Sync mode the DI filter will need to be set to two counts, to avoid the QT1106 response time being unacceptably lengthened as a consequence of this.

**Figure 4.2 LP Mode SPI Operation with LPB = 0**

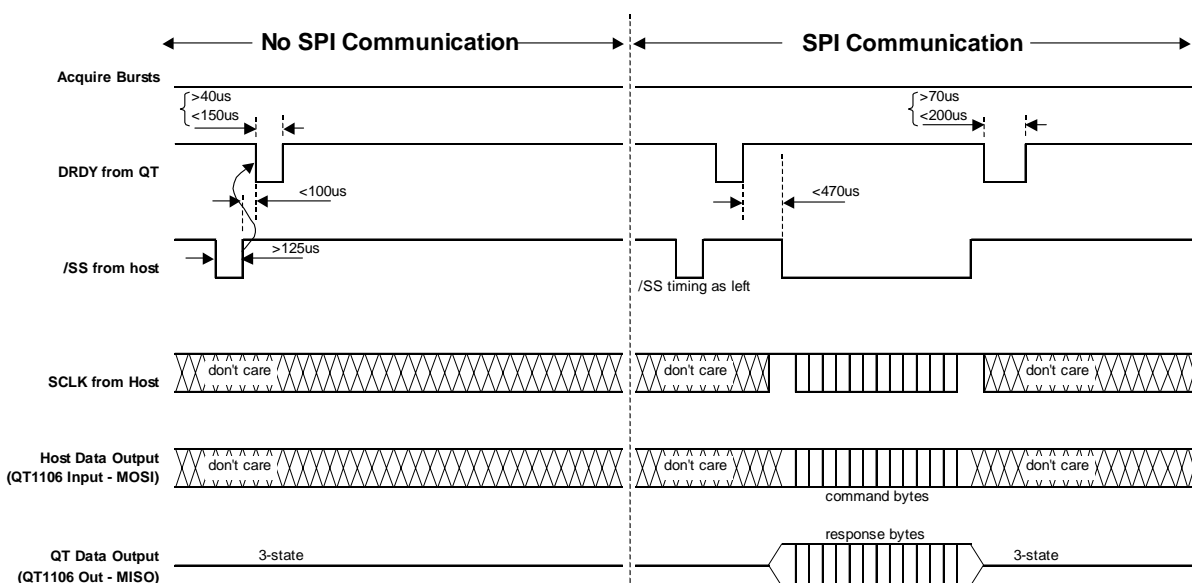

## 5 Reset

### 5.1 Introduction

When starting from power-up or /RST reset there are a few additional factors to be aware of. In most applications the host will not need to take special action.

During hardware reset all outputs are disabled. To define the levels of the CHANGE and DRDY during reset these signals should be pulled down by resistors to 0V. Otherwise, they may drift high causing the host to detect a false logic 1.

When the initial reset phase ends, CHANGE and DRDY outputs are enabled. DRDY will drive low and CHANGE will drive high.

### 5.2 Delay to SPI Functionality

The QT1106 SPI interface is not operational while the device is being reset. However, SPI is made operational early in the start-up procedure.

After any reset (either via the /RST pin or via power-up), SPI typically becomes operational within 100ms of /RST going high or power-up. This is indicated to the host by DRDY being pulsed high for at least 450 $\mu$ s, as occurs between groups of acquire bursts when in Free Run mode. The maximum delay is:

Vdd  $\geq$  4.5V: 150ms

Vdd < 4.5V: 200ms

### 5.3 Reset Delay to Touch Detection

After power up or reset, the QT1106 calibrates all electrodes. During this time, touch detection cannot be reported. Four dummy bursts are performed in 80ms after exiting from the reset start-up delay. Calibration completes after 14 burst cycles, which normally requires an additional 280ms.

In total, 460ms are required from reset or power-up for the device to be fully functional.

**Disabled Keys:** Keys with missing Cs capacitors, or that otherwise have an out-of-range signal during calibration, are considered to be unused or faulty and are disabled. Disabled keys are re-examined for operation after each reset or recalibration event.

### 5.4 Mode Setting After Reset

After a reset the device will enter Free Run mode, with AKS disabled.

## 6 Design Notes

### 6.1 Oscillator Frequency

The oscillator uses an external network connected to the OSC and SPREAD pins as shown in Figure 2.1. The charts in this figure show the recommended values to use depending on nominal operating voltage and spread-spectrum mode.

If spread-spectrum mode is not used, only resistor R<sub>B1</sub> should be used, the C<sub>SS</sub> capacitor eliminated, and the SPREAD pin pulled to V<sub>SS</sub> with a 100k resistor.

An out-of-specification oscillator can induce timing problems such as large variations in response times as well as on the SPI port.

### 6.2 Spread-spectrum Circuit

The QT1106 offers the ability to spectrally spread its frequency of operation to heavily reduce susceptibility to external noise sources and to limit RF emissions. The SPREAD pin is used to modulate an external passive RC network that modulates the OSC pin. OSC is the main oscillator current input. The circuit and recommended values are shown in Figure 2.1.

The resistors R<sub>b1</sub> and R<sub>b2</sub> should be changed, depending on V<sub>DD</sub>. As shown in Figure 2.1, three sets of values are recommended for these resistors, depending on V<sub>DD</sub>. The power curves in Section 7.6 also show the effect of these resistors.

The spread-spectrum circuit can be eliminated if it is not desired; see Section 6.1. Non spread-spectrum mode consumes less current in the low power modes.

The spread-spectrum RC network should be adjusted to suit the acquire burst lengths. The sawtooth waveform observed on SPREAD should reach a crest height as follows:

Vdd  $\geq$  3.6V: 17 percent of Vdd  
Vdd < 3.6V: 20 percent of Vdd

The C<sub>SS</sub> capacitor connected to SPREAD (see Figure 2.1) should be adjusted so that the waveform approximates the above amplitude,  $\pm$ 10 percent, during normal operation in the target circuit. If this is done, the circuit will give a spectral modulation of 12 to 15 percent.

In cases where the three acquire bursts 1, 2, 3 are of different lengths, the C<sub>SS</sub> capacitor should be adjusted for the longest acquire burst.

### 6.3 Cs Sample Capacitors - Sensitivity

The C<sub>s</sub> sample capacitors accumulate the charge from the key electrodes and determine sensitivity. Higher values of C<sub>s</sub> make the corresponding sensing channel more sensitive. The values of C<sub>s</sub> can differ for each channel, permitting differences in sensitivity from key to key or to balance unequal sensitivities.

Unequal sensitivities can occur due to key size and placement differences and stray wiring capacitances. More stray capacitance on a sense trace will desensitize the corresponding key; increasing the C<sub>s</sub> for that key will compensate for the loss of sensitivity.

The C<sub>s</sub> capacitors can be virtually any plastic film or low to medium-K ceramic capacitor. The 'normal' C<sub>s</sub> range is 1nF to 100nF for the keys and 4.7nF to 220nF for the wheel/slider, depending on the sensitivity required; the larger values of C<sub>s</sub> require better quality to ensure reliable sensing. Acceptable capacitor types for most uses include PPS film, polypropylene film, and NP0 and X7R ceramics. Lower grade ceramics than X7R are not advised; the X5R grade should be avoided because it is less stable than X7R.



## 6.4 Rsns Resistors

Series resistors  $R_{SNS}$  ( $R_{SNSA1}...R_{SNSA3}$ ,  $R_{SNSB1}...R_{SNSB7}$ ) are in-line with the electrode connections and are used to limit electrostatic discharge (ESD) currents and to suppress radio frequency interference (RFI). For most applications  $R_{SNSB}$  will be in the range 4.7k $\Omega$  to 33k $\Omega$  each. In a few applications with low loading on the sense keys the value may be up to 100k $\Omega$ .

Although these resistors may be omitted, the device may become susceptible to external noise or RFI. For details of how to select these resistors see the Application Note AN-KD02, downloadable from the Quantum website <http://www.qprox.com> (go to the Support tab and click Application Notes).

## 6.5 Thermal Stability

The QT1106 can operate with or without the wheel/slider and supports up to seven keys. Channels not fitted with a sense capacitor will automatically be switched off during calibration.

For better thermal stability while operating with only one key, it is best to fit a sense capacitor of the same type and value for another spare key channel, in another burst group. Additionally a small value  $C_x$  (~5pF COG) should be fitted to simulate electrode capacitance.

The  $C_x$  value required for best thermal stability can be obtained by matching the burst lengths of the key channel and the dummy channel. The burst lengths of the channels can be captured on an oscilloscope via the coin method, as described in the Application note AN-KD02 (see Section 6.4). This provides a stable reference for increased thermal stability.

## 6.6 Power Supply

The power supply can range from 2.8 to 5.0 volts. If this fluctuates slowly with temperature, the device will track and compensate for these changes automatically with only minor changes in sensitivity. If the supply voltage drifts or shifts quickly, the drift compensation mechanism will not be able to keep up, causing sensitivity anomalies or false detections.

The QT1106 power supply should be locally regulated using a three-terminal device, to between 2.8V and 5.0V. If the supply is shared with another electronic system, care should be taken to ensure that the supply is free of digital spikes, sags, and surges, all of which can cause adverse effects.

For proper operation a 0.1 $\mu$ F, or greater, bypass capacitor must be used between Vdd and Vss; the bypass capacitor should be routed with very short tracks to the QT1106's Vss and Vdd pins.

## 6.7 PCB Layout and Construction

Refer to the Application Note AN-KD02 'Secrets of a Successful QTouch Design', downloadable from the Quantum web site <http://www.qprox.com> (go to the Support tab and click Application Notes) for information related to layout and construction matters. Downloadable example CAD files for wheels and sliders can also be found on the website)

The sensing channels used for the individual keys can be implemented as per AN-KD02.

## 7 Specifications

### 7.1 Absolute Maximum Specifications

Operating temperature, Ta	-40 to +85°C
Storage temp, Ts	-50 to +125°C
Vdd	-0.3 to +6.0V
Max continuous pin current, any control or drive pin	±20mA
Short circuit duration to ground or Vdd, any pin	infinite
Voltage forced onto any pin	-0.3V to (Vdd + 0.3) Volts

### 7.2 Recommended Operating Conditions

Operating temperature, Ta	-40 to +85°C
Vdd	+2.8 to +5.0V
Short-term supply ripple+noise	±5mV/s
Long-term supply stability	±100mV
Cs range keys	1nF to 100nF
Cs range wheel/slider	4.7nF to 220nF
Cx range	0 to 50pF

### 7.3 AC Specifications

Vdd = 5.0V, Ta = recommended, Cx = 5pF, Cs keys = 4.7nF, Cs wheel/slider = 15nF, no spread-spectrum network, Rb1 = 20kΩ; circuit of Figure 2.1.

Parameter	Description	Min	Typ	Max	Units	Notes
Tsu	Start-up to SPI time		100	150 200	ms	From cold start Vdd ≥ 4.5V Vdd < 4.5V
Trc	Recalibration time		280		ms	
Fc	Burst center frequency		125		kHz	
Fm	Burst modulation, percent		15		%	Total deviation
Tpc	Sample pulse duration		2.33		µs	Keys
Tbd	Acquire burst duration		20		ms	Total for all three acquire burst groups
Tdf6	Response time - Free Run mode, DI 6 samples		120		ms	
Tdf2	Response time - Free Run mode, DI 2 samples		40		ms	
Tdl	Response time - LP mode		280		ms	280ms LP setting, DI = six counts
Tdr	Release time - all modes		40		ms	End of touch

### 7.4 DC Specifications

Vdd = 5.0V, Ta = recommended, Cx = 5pF, Cs keys = 4.7nF, Cs wheel/slider = 15nF, no spread-spectrum network, Rb1 = 20kΩ; circuit of Figure 2.1.

Parameter	Description	Min	Typ	Max	Units	Notes
Idd (FR)	Average supply current, Free Run mode		3.6 2.2 1.9 1.6 1.3	8	mA	Vdd = 5.0 Vdd = 4.0 Vdd = 3.6 Vdd = 3.3 Vdd = 2.8
Idd (LP280)	Average supply current, 280ms LP mode		<165		µA	Vdd = 3.0
Idd (LP760)	Average supply current, 760ms LP mode		<75		µA	Vdd = 3.0
Idd (Sleep)	Average supply current, Sleep mode		<6		µA	Vdd = 3.0
Vdds	Supply turn-on slope	100			V/s	Required for start-up, w/o external reset cct
Vil	Low input logic level	0		0.3Vdd	V	
Vhl	High input logic level	0.7Vdd		Vdd	V	
Vol	Low output voltage			0.5	V	7mA sink
Voh	High output voltage	Vdd-0.5			V	2.5mA source
Iil	Input leakage current			±1	µA	
Ar	Acquisition resolution		14		bits	



## 7.5 Signal Processing

Vdd = 5.0V, Ta = recommended, Cx = 5pF, Cs keys = 4.7nF, Cs wheel/slider = 15nF, no spread-spectrum network, Rb1 = 20kΩ; circuit of Figure 2.1

Description	Value	Units	Notes
Detection threshold (keys)	10	counts	Threshold for increase in Cx load
Detection threshold (wheel/slider)	40	counts	Changeable through SPI
Detection hysteresis (keys)	2	counts	
Detection hysteresis (wheel/slider)	5	counts	12.5 percent of wheel/slider detection threshold.
DI filter, start of touch, normal mode	6	samples	Must be consecutive or detection fails
DI filter, start of touch, fast DI mode	2	samples	Must be consecutive or detection fails
DI filter, end of touch	2	samples	
Anti-detection threshold	8	counts	Threshold for decrease of Cx load
Anti-detection filter	6	samples	
Faulty channel filter	1	samples	
Maximum On-duration	10, 20, 60, infinite	secs	In these modes: Free Run, 200ms LP, 280ms LP, Sync with 55Hz sync

## 7.6 Idd Curves

**Table 7.1 Typical Average Idd Curves (No Spread Spectrum)**

Cs (keys) = 4.7nF, Cs (wheel) = 15nF Ta = 20°, no spread-spectrum circuit (see Figure 2.1).

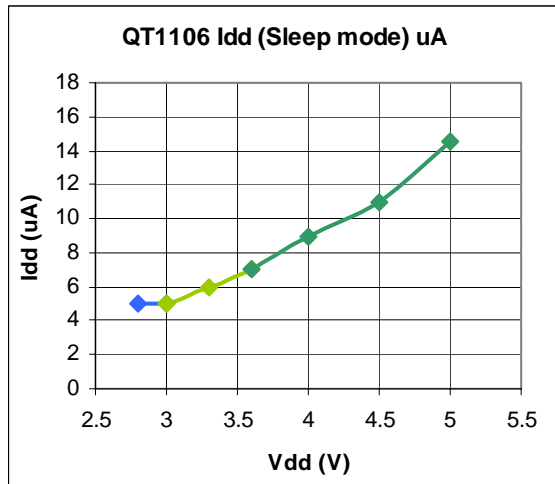
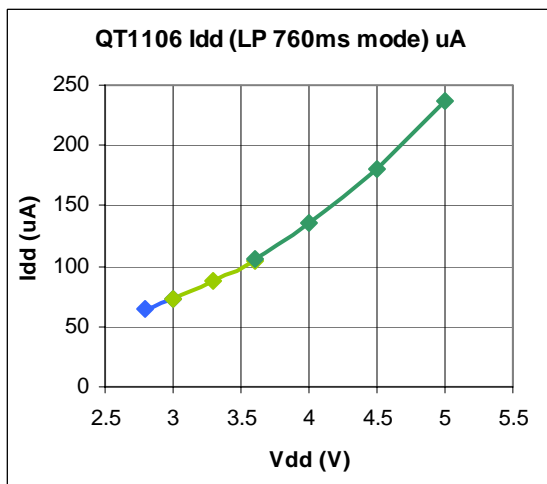
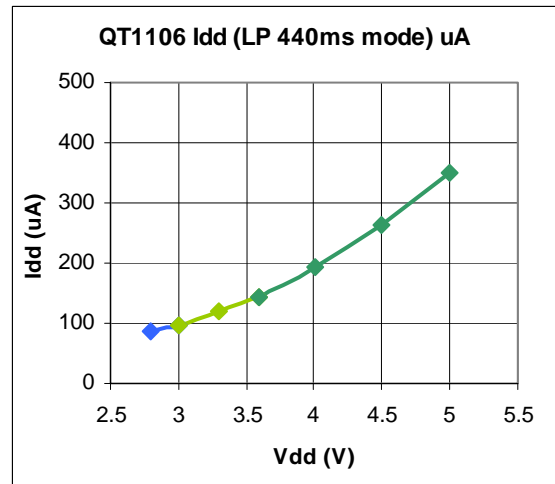
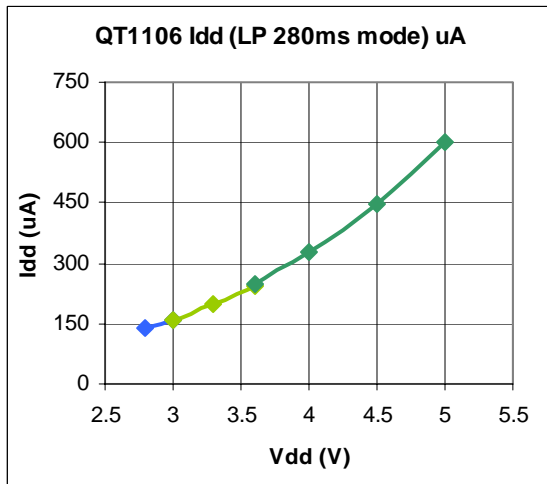
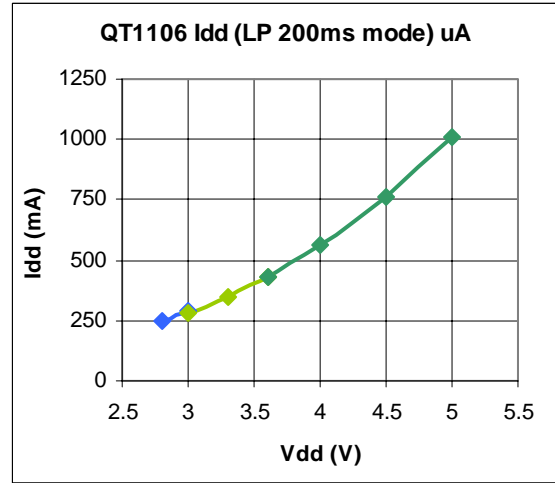
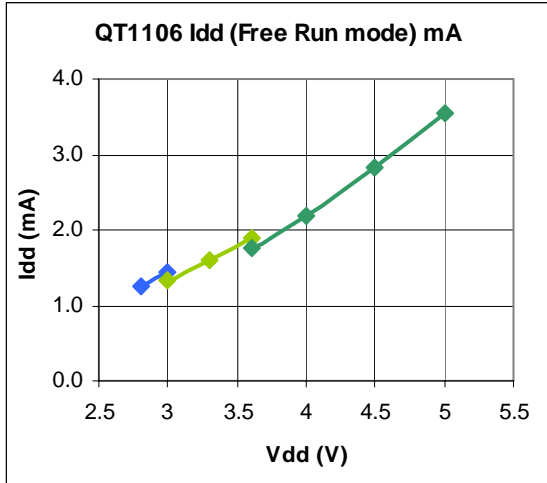
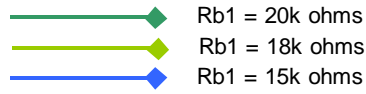

**Table 7.2 Typical Average Idd Curves (Spread Spectrum)**

Cs (keys) = 4.7nF, Cs (wheel) = 15nF Ta = 20°, spread-spectrum circuit (see Figure 2.1).

- ◆ Rb1 = 15k ohms, Rb2 = 27k ohms, Css = 100nF
- ◆ Rb1 = 12k ohms, Rb2 = 22k ohms, Css = 100nF
- ◆ Rb1 = 12k ohms, Rb2 = 27k ohms, Css = 100nF

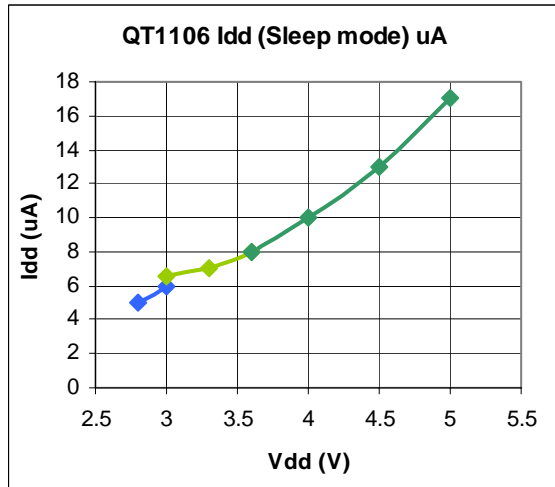
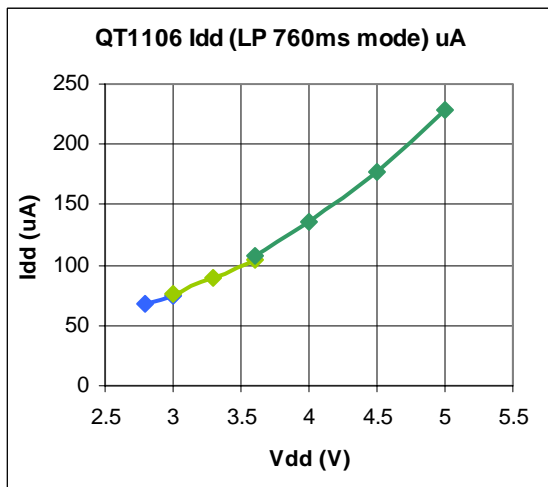
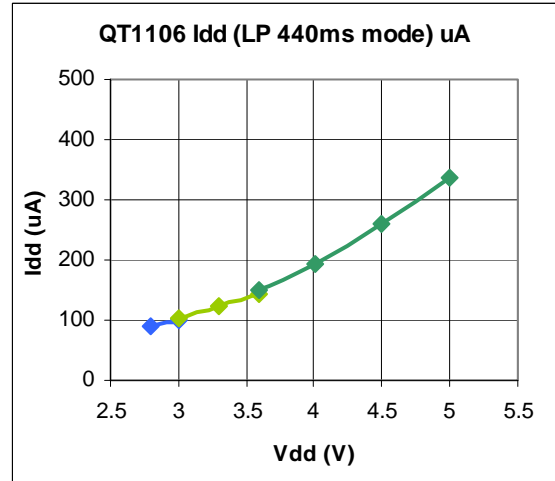
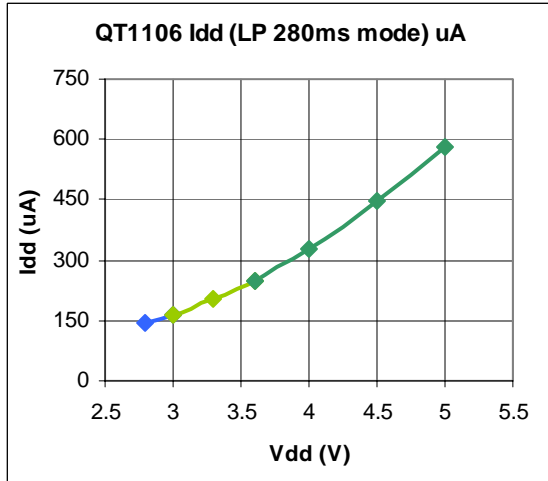
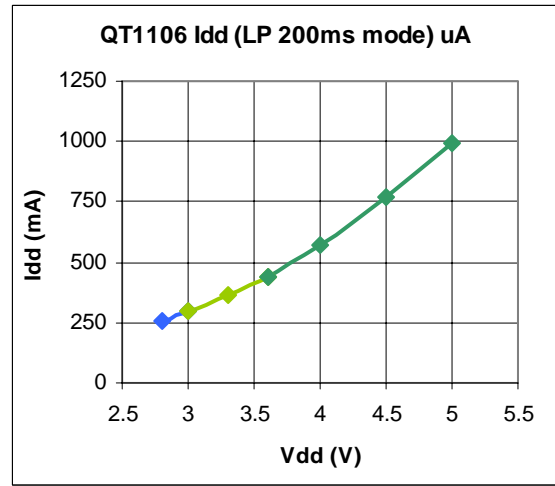
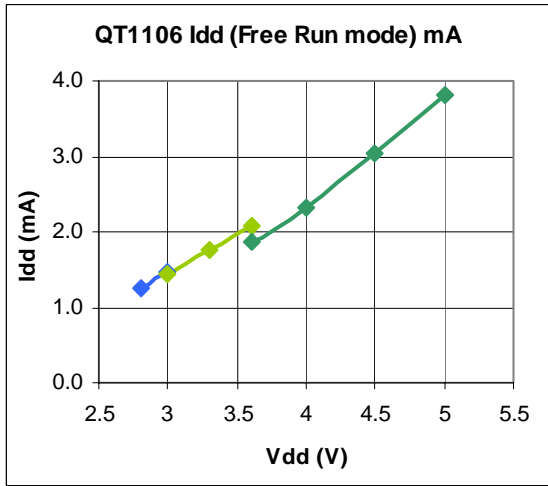

## 7.7 Mechanical Dimensions - 32-QFN Package

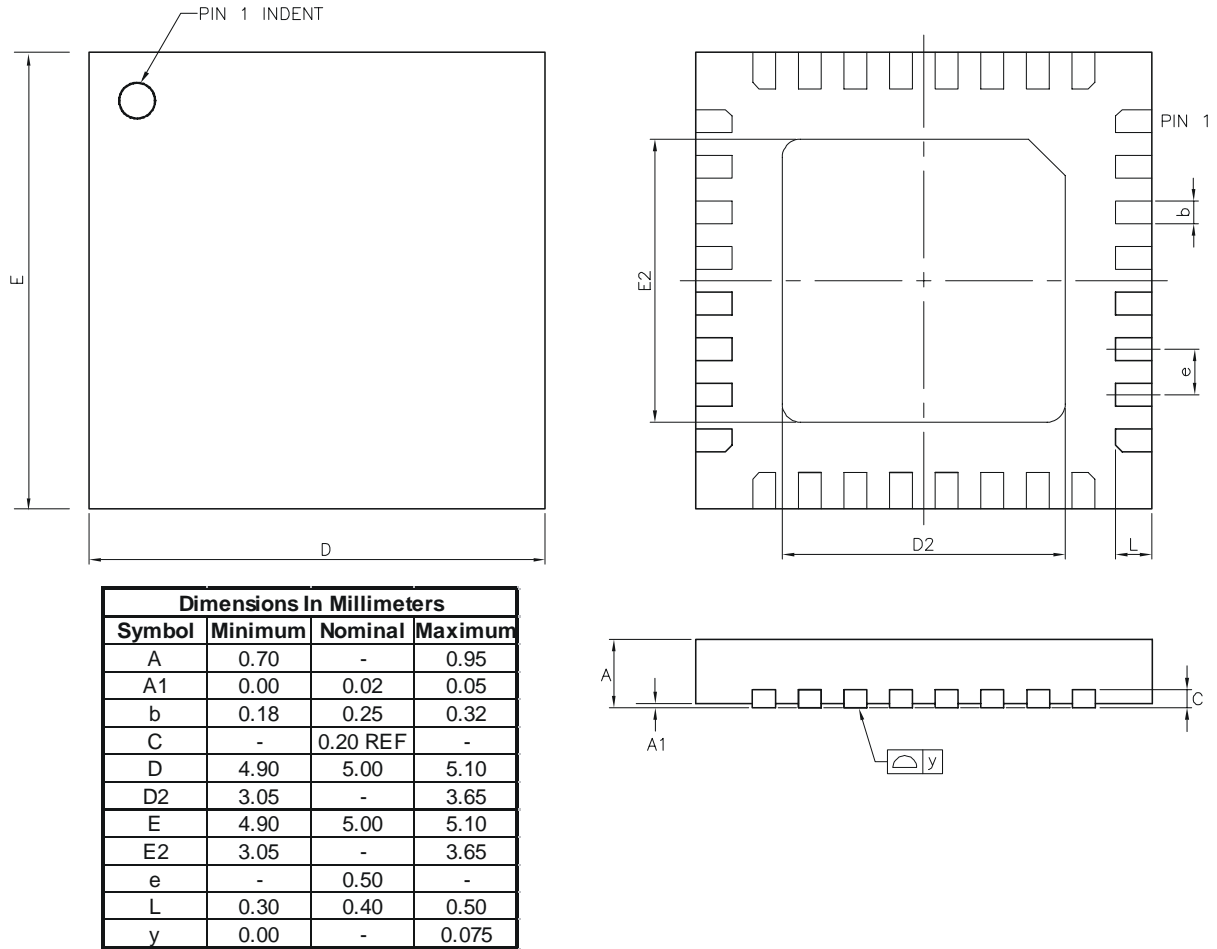

**Note:** there is no functional requirement for the large pad on the underside of the 32-QFN package to be soldered to the substrate. If the final application does require this area to be soldered for mechanical reasons, the pad(s) to which it is soldered to must be isolated and contained under the 32-QFN footprint only.

## 7.8 Part Marking

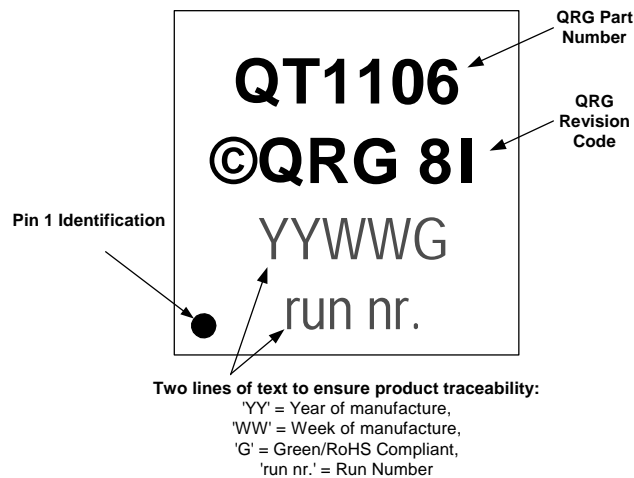

## 7.9 Moisture Sensitivity Level (MSL)

MSL Rating	Peak Body Temperature	Specifications
MSL3	260°C	IPC/JEDEC J-STD-020C

## 8 Datasheet Control

### 8.1 Changes

#### Changes this issue (datasheet issue 6)

Front page  
Section 2.8.  
Section 6.4, 6.5  
Section 7.9  
Section 8  
Rear page

### 8.2 Numbering Convention

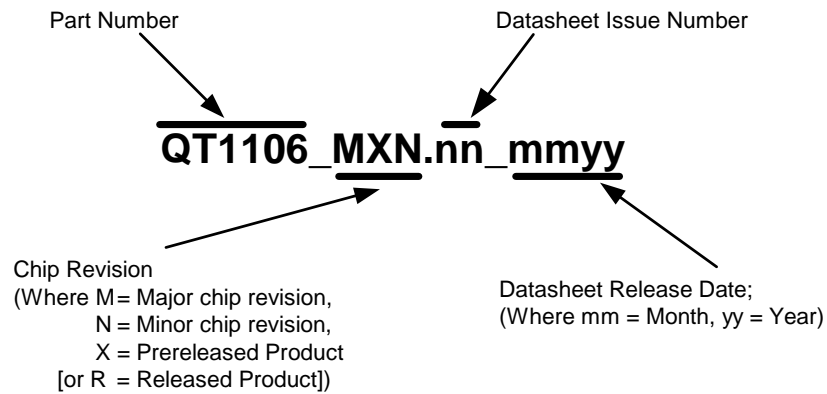

*A minor chip revision (N) is defined as a revision change which does not affect product functionality or datasheet.  
The value of N is only stated for released parts (R).*



Copyright © 2006-2007 QRG Ltd. All rights reserved.  
Patented and patents pending

### **Corporate Headquarters**

1 Mitchell Point  
Ensign Way, Hamble SO31 4RF  
Great Britain  
Tel: +44 (0)23 8056 5600 Fax: +44 (0)23 8045 3939

**[www.qprox.com](http://www.qprox.com)**

### **North America**

651 Holiday Drive Bldg. 5 / 300  
Pittsburgh, PA 15220 USA  
Tel: 412-391-7367 Fax: 412-291-1015

The specifications set out in this document are subject to change without notice. All products sold and services supplied by QRG are subject to QRG's Terms and Conditions of sale and services. QRG patents, trademarks and Terms and Conditions can be found online at <http://www.qprox.com/about/legal.php>. Numerous further patents are pending, one or more which may apply to this device or the applications thereof.

QRG products are not suitable for medical (including lifesaving equipment), safety or mission critical applications or other similar purposes. Except as expressly set out in QRG's Terms and Conditions, no licenses to patents or other intellectual property of QRG (express or implied) are granted by QRG in connection with the sale of QRG products or provision of services. QRG will not be liable for customer product design and customers are entirely responsible for their products and applications which incorporate QRG's products.

***Development Team: Lim Wei Jiun, Martin Simmons, Alan Bowens, Luben Hristov***