

Features

- High Performance, Low Power AVR[®] 8-bit Microcontroller
- Advanced RISC Architecture
 - 129 Powerful Instructions - Most Single Clock Cycle Execution
 - 32 x 8 General Purpose Working Registers
 - Fully Static Operation
 - Up to 1 MIPS throughput per MHz
 - On-chip 2-cycle Multiplier
- Data and Non-Volatile Program Memory
 - 8K Bytes Flash of In-System Programmable Program Memory
 - Endurance: 10,000 Write/Erase Cycles
 - Optional Boot Code Section with Independent Lock Bits
- In-System Programming by On-chip Boot Program
- True Read-While-Write Operation
 - 512 Bytes of In-System Programmable EEPROM
- Endurance: 100,000 Write/Erase Cycles
 - 512 Bytes Internal SRAM
 - Programming Lock for Flash Program and EEPROM Data Security
- On Chip Debug Interface (debugWIRE)
- Peripheral Features
 - Two or three 12-bit High Speed PSC (Power Stage Controllers) with 4-bit Resolution Enhancement
 - Non Overlapping Inverted PWM Output Pins With Flexible Dead-Time
 - Variable PWM duty Cycle and Frequency
 - Synchronous Update of all PWM Registers
 - Auto Stop Function for Event Driven PFC Implementation
 - Less than 25 Hz Step Width at 150 kHz Output Frequency
 - PSC2 with four Output Pins and Output Matrix
 - One 8-bit General purpose Timer/Counter with Separate Prescaler and Capture Mode
 - One 16-bit General purpose Timer/Counter with Separate Prescaler, Compare Mode and Capture Mode
 - Programmable Serial USART
 - Standard UART mode
 - 16/17 bit Biphase Mode for DALI Communications
 - Master/Slave SPI Serial Interface
 - 10-bit ADC
 - Up To 11 Single Ended Channels and 2 Fully Differential ADC Channel Pairs
 - Programmable Gain (5x, 10x, 20x, 40x on Differential Channels)
 - Internal Reference Voltage
 - 10-bit DAC
 - Two or three Analog Comparator with Resistor-Array to Adjust Comparison Voltage
 - 4 External Interrupts
 - Programmable Watchdog Timer with Separate On-Chip Oscillator
- Special Microcontroller Features
 - Low Power Idle, Noise Reduction, and Power Down Modes
 - Power On Reset and Programmable Brown Out Detection
 - Flag Array in Bit-programmable I/O Space (4 bytes)



**8-bit AVR[®]
Microcontroller
with 8K Bytes
In-System
Programmable
Flash**

**AT90PWM2
AT90PWM3**

**AT90PWM2B
AT90PWM3B**

Summary





- In-System Programmable via SPI Port
- Internal Calibrated RC Oscillator (8 MHz)
- On-chip PLL for fast PWM (32 MHz, 64 MHz) and CPU (16 MHz)
- Operating Voltage: 2.7V - 5.5V
- Extended Operating Temperature:
 - -40°C to +105°

Product	Package	12 bit PWM with deadtime	ADC Input	ADC Diff	Analog Compar	Application
AT90PWM2 AT90PWM2B	SO24	2 x 2	8	1	2	One fluorescent ballast
AT90PWM3 AT90PWM3B	SO32, QFN32	3 x 2	11	2	3	HID ballast, fluorescent ballast, Motor control

1. History

Product	Revision
AT90PWM2 AT90PWM3	First revision of parts, only for running production.
AT90PWM2B AT90PWM3B	<p>Second revision of parts, for all new developments. The major changes are :</p> <ul style="list-style-type: none"> • complement the PSCOUT01, PSCOUT11, PSCOUT21 polarity in centered mode - See “PSCn0 & PSCn1 Basic Waveforms in Center Aligned Mode” on page 139. • Add the PSC software triggering capture - See “PSC 0 Input Capture Register – PICR0H and PICR0L” on page 170. • Add bits to read the PSC output activity - See “PSC0 Interrupt Flag Register – PIFR0” on page 172. • Add some clock configurations - See “Device Clocking Options Select AT90PWM2B/3B” on page 31. • Change Amplifier Synchronization - See “Amplifier” on page 252. and See “” on page 254. • Correction of the Errata - See “Errata” on page 23.

This datasheet deals with product characteristics of AT90PW2 and AT90WM3. It will be updated as soon as characterization will be done.

2. Disclaimer

Typical values contained in this datasheet are based on simulations and characterization of other AVR microcontrollers manufactured on the same process technology. Min and Max values will be available after the device is characterized.

3. Pin Configurations

Figure 3-1. SOIC 24-pin Package

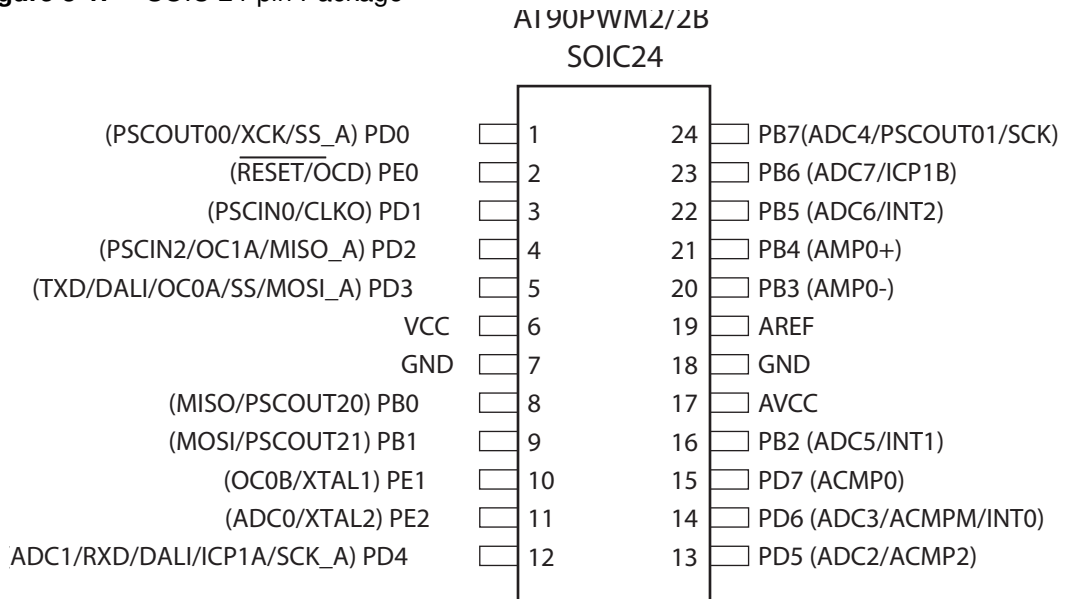

Figure 3-2. SOIC 32-pin Package

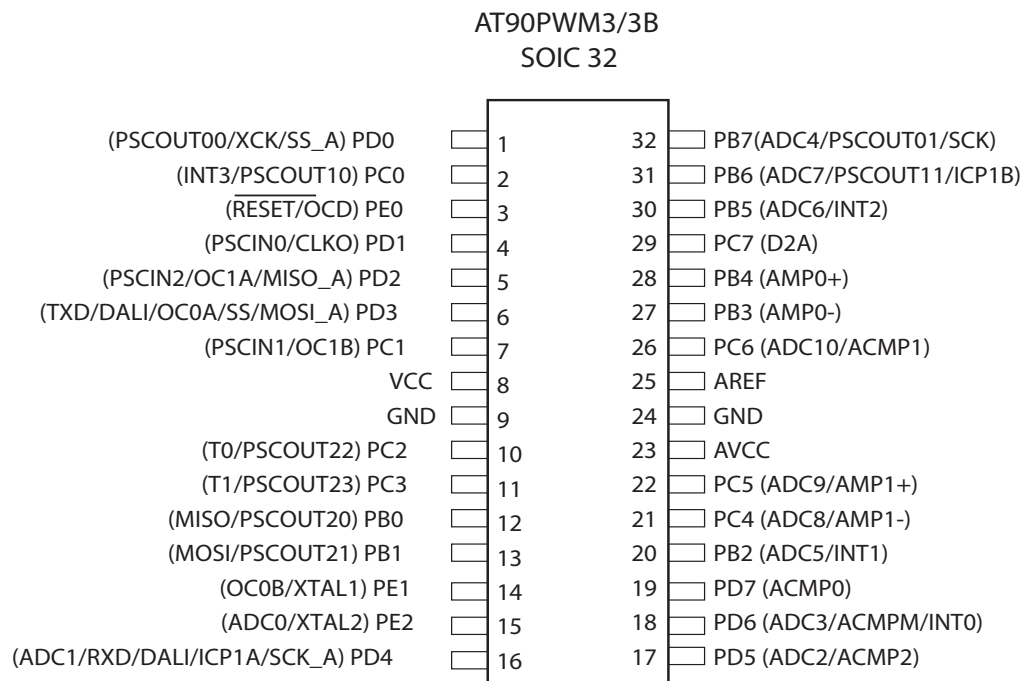
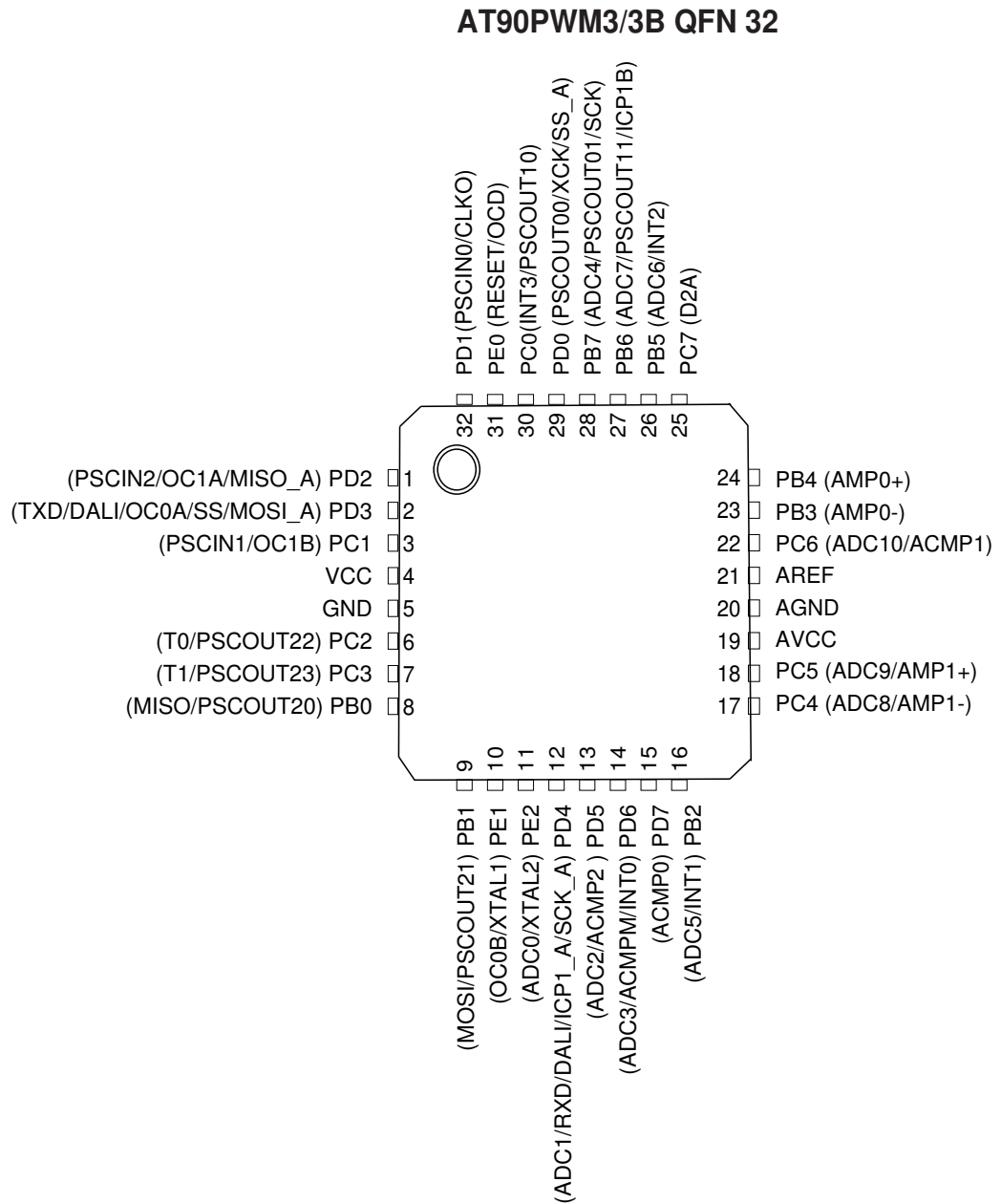

Figure 3-3. QFN32 (7*7 mm) Package.



3.1 Pin Descriptions

Table 3-1. Pin out description

S024 Pin Number	S032 Pin Number	QFN32 Pin Number	Mnemonic	Type	Name, Function & Alternate Function
7	9	5	GND	Power	Ground: 0V reference
18	24	20	AGND	Power	Analog Ground: 0V reference for analog part

Table 3-1. Pin out description (Continued)

S024 Pin Number	SO32 Pin Number	QFN32 Pin Number	Mnemonic	Type	Name, Function & Alternate Function
6	8	4	VCC	power	Power Supply:
17	23	19	AVCC	Power	Analog Power Supply: This is the power supply voltage for analog part For a normal use this pin must be connected.
19	25	21	AREF	Power	Analog Reference : reference for analog converter . This is the reference voltage of the A/D converter. As output, can be used by external analog
8	12	8	PBO	I/O	MISO (SPI Master In Slave Out) PSCOUT20 output
9	13	9	PB1	I/O	MOSI (SPI Master Out Slave In) PSCOUT21 output
16	20	16	PB2	I/O	ADC5 (Analog Input Channel5) INT1
20	27	23	PB3	I/O	AMP0- (Analog Differential Amplifier 0 Input Channel)
21	28	24	PB4	I/O	AMP0+ (Analog Differential Amplifier 0 Input Channel)
22	30	26	PB5	I/O	ADC6 (Analog Input Channel 6) INT 2
23	31	27	PB6	I/O	ADC7 (Analog Input Channel 7) ICP1B (Timer 1 input capture alternate input) PSCOUT11 output (see note 1)
24	32	28	PB7	I/O	PSCOUT01 output ADC4 (Analog Input Channel 4) SCK (SPI Clock)
NA	2	30	PC0	I/O	PSCOUT10 output (see note 1) INT3
	7	3	PC1	I/O	PSCIN1 (PSC 1 Digital Input) OC1B (Timer 1 Output Compare B)
	10	6	PC2	I/O	T0 (Timer 0 clock input) PSCOUT22 output
	11	7	PC3	I/O	T1 (Timer 1 clock input) PSCOUT23 output
	21	17	PC4	I/O	ADC8 (Analog Input Channel 8) AMP1- (Analog Differential Amplifier 1 Input Channel)
	22	18	PC5	I/O	ADC9 (Analog Input Channel 9) AMP1+ (Analog Differential Amplifier 1 Input Channel)
	26	22	PC6	I/O	ADC10 (Analog Input Channel 10) ACMP1 (Analog Comparator 1 Positive Input)
	29	25	PC7	I/O	D2A : DAC output

Table 3-1. Pin out description (Continued)

S024 Pin Number	SO32 Pin Number	QFN32 Pin Number	Mnemonic	Type	Name, Function & Alternate Function
1	1	29	PD0	I/O	PSCOUT00 output XCK (UART Transfer Clock) SS_A (Alternate SPI Slave Select)
3	4	32	PD1	I/O	PSCIN0 (PSC 0 Digital Input) CLKO (System Clock Output)
4	5	1	PD2	I/O	PSCIN2 (PSC 2 Digital Input) OC1A (Timer 1 Output Compare A) MISO_A (Programming & alternate SPI Master In Slave Out)
5	6	2	PD3	I/O	TXD (Dali/UART Tx data) OC0A (Timer 0 Output Compare A) SS (SPI Slave Select) MOSI_A (Programming & alternate Master Out SPI Slave In)
12	16	12	PD4	I/O	ADC1 (Analog Input Channel 1) RXD (Dali/UART Rx data) ICP1A (Timer 1 input capture) SCK_A (Programming & alternate SPI Clock)
13	17	13	PD5	I/O	ADC2 (Analog Input Channel 2) ACMP2 (Analog Comparator 2 Positive Input)
14	18	14	PD6	I/O	ADC3 (Analog Input Channel 3) ACMPM reference for analog comparators INT0
15	19	15	PD7	I/O	ACMP0 (Analog Comparator 0 Positive Input)
2	3	31	PE0	I/O or I	RESET (Reset Input) OCD (On Chip Debug I/O)
10	14	10	PE1	I/O	XTAL1: XTAL Input OC0B (Timer 0 Output Compare B)
11	15	11	PE2	I/O	XTAL2: XTAL OuTput ADC0 (Analog Input Channel 0)

1. PSCOUT10 & PSCOUT11 are not present on 24 pins package

4. Overview

The AT90PWM2/2B/3/3B is a low-power CMOS 8-bit microcontroller based on the AVR enhanced RISC architecture. By executing powerful instructions in a single clock cycle, the AT90PWM2/2B/3/3B achieves throughputs approaching 1 MIPS per MHz allowing the system designer to optimize power consumption versus processing speed.

4.1 Block Diagram

Figure 4-1. Block Diagram

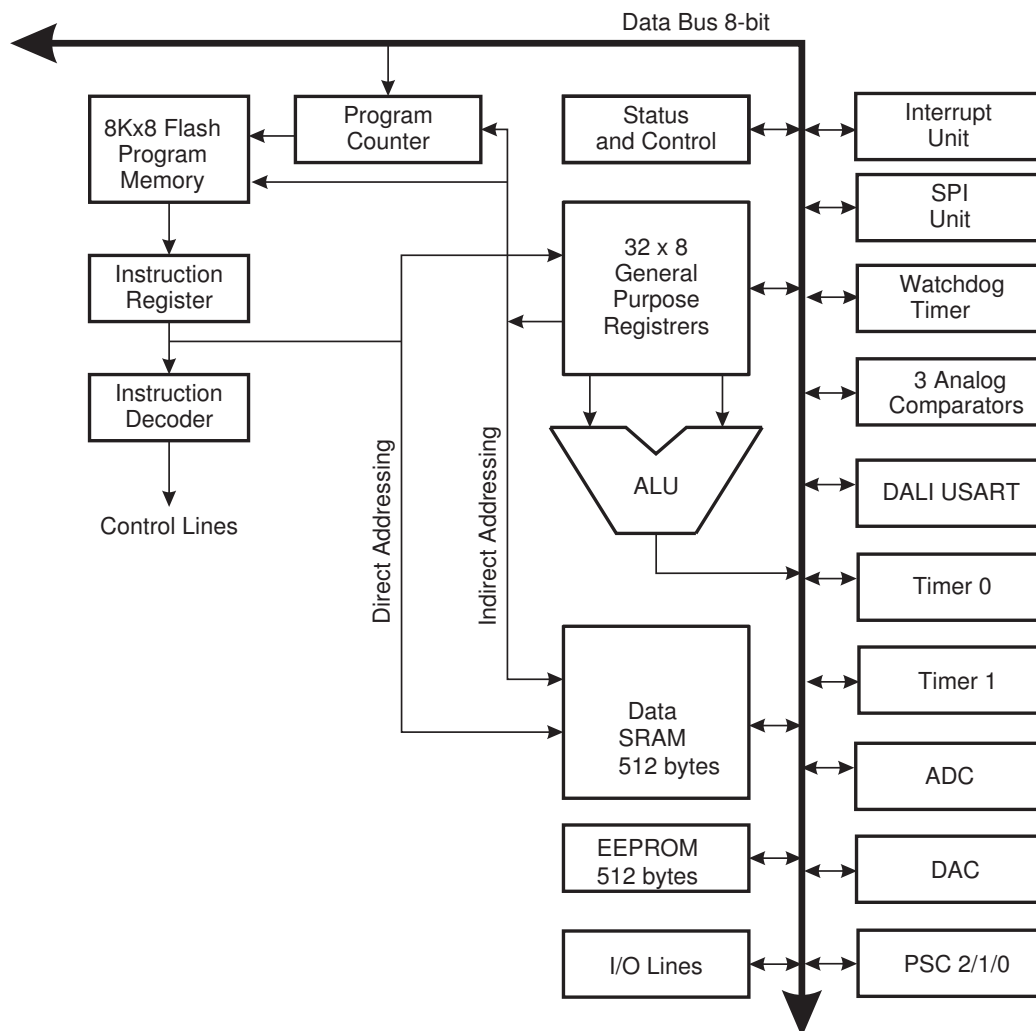

The AVR core combines a rich instruction set with 32 general purpose working registers. All the 32 registers are directly connected to the Arithmetic Logic Unit (ALU), allowing two independent registers to be accessed in one single instruction executed in one clock cycle. The resulting architecture is more code efficient while achieving throughputs up to ten times faster than conventional CISC microcontrollers.

The AT90PWM2/2B/3/3B provides the following features: 8K bytes of In-System Programmable Flash with Read-While-Write capabilities, 512 bytes EEPROM, 512 bytes SRAM, 53 general purpose I/O lines, 32 general purpose working registers, three Power Stage Controllers, two flexible Timer/Counters with compare modes and PWM, one USART with DALI mode, an 11-channel 10-bit ADC with two differential input stage with programmable gain, a 10-bit DAC, a programmable Watchdog Timer with Internal Oscillator, an SPI serial port, an On-chip Debug system and four software selectable power saving modes.

The Idle mode stops the CPU while allowing the SRAM, Timer/Counters, SPI ports and interrupt system to continue functioning. The Power-down mode saves the register contents but freezes the Oscillator, disabling all other chip functions until the next interrupt or Hardware Reset. The ADC Noise Reduction mode stops the CPU and all I/O modules except ADC, to minimize switching noise during ADC conversions. In Standby mode, the Crystal/Resonator Oscillator is running while the rest of the device is sleeping. This allows very fast start-up combined with low power consumption.

The device is manufactured using Atmel's high-density nonvolatile memory technology. The On-chip ISP Flash allows the program memory to be reprogrammed in-system through an SPI serial interface, by a conventional nonvolatile memory programmer, or by an On-chip Boot program running on the AVR core. The boot program can use any interface to download the application program in the application Flash memory. Software in the Boot Flash section will continue to run while the Application Flash section is updated, providing true Read-While-Write operation. By combining an 8-bit RISC CPU with In-System Self-Programmable Flash on a monolithic chip, the Atmel AT90PWM2/3 is a powerful microcontroller that provides a highly flexible and cost effective solution to many embedded control applications.

The AT90PWM2/3 AVR is supported with a full suite of program and system development tools including: C compilers, macro assemblers, program debugger/simulators, in-circuit emulators, and evaluation kits.

4.2 Pin Descriptions

4.2.1 VCC

Digital supply voltage.

4.2.2 GND

Ground.

4.2.3 Port B (PB7..PB0)

Port B is an 8-bit bi-directional I/O port with internal pull-up resistors (selected for each bit). The Port B output buffers have symmetrical drive characteristics with both high sink and source capability. As inputs, Port B pins that are externally pulled low will source current if the pull-up resistors are activated. The Port B pins are tri-stated when a reset condition becomes active, even if the clock is not running.

Port B also serves the functions of various special features of the AT90PWM2/2B/3/3B as listed on [page 69](#).

4.2.4 Port C (PC7..PC0)

Port C is an 8-bit bi-directional I/O port with internal pull-up resistors (selected for each bit). The Port C output buffers have symmetrical drive characteristics with both high sink and source capability. As inputs, Port C pins that are externally pulled low will source current if the pull-up resistors are activated. The Port C pins are tri-stated when a reset condition becomes active, even if the clock is not running.

Port C is not available on 24 pins package.

Port C also serves the functions of special features of the AT90PWM2/2B/3/3B as listed on [page 71](#).

4.2.5 Port D (PD7..PD0)

Port D is an 8-bit bi-directional I/O port with internal pull-up resistors (selected for each bit). The Port D output buffers have symmetrical drive characteristics with both high sink and source capability. As inputs, Port D pins that are externally pulled low will source current if the pull-up resistors are activated. The Port D pins are tri-stated when a reset condition becomes active, even if the clock is not running.

Port D also serves the functions of various special features of the AT90PWM2/2B/3/3B as listed on [page 74](#).

4.2.6 Port E (PE2..0) RESET/ XTAL1/ XTAL2

Port E is a 3-bit bi-directional I/O port with internal pull-up resistors (selected for each bit). The Port E output buffers have symmetrical drive characteristics with both high sink and source capability. As inputs, Port E pins that are externally pulled low will source current if the pull-up resistors are activated. The Port E pins are tri-stated when a reset condition becomes active, even if the clock is not running.

If the RSTDISBL Fuse is programmed, PE0 is used as an I/O pin. Note that the electrical characteristics of PE0 differ from those of the other pins of Port C.

If the RSTDISBL Fuse is unprogrammed, PE0 is used as a Reset input. A low level on this pin for longer than the minimum pulse length will generate a Reset, even if the clock is not running. The minimum pulse length is given in [Table 9-1 on page 47](#). Shorter pulses are not guaranteed to generate a Reset.

Depending on the clock selection fuse settings, PE1 can be used as input to the inverting Oscillator amplifier and input to the internal clock operating circuit.

Depending on the clock selection fuse settings, PE2 can be used as output from the inverting Oscillator amplifier.

The various special features of Port E are elaborated in [“Alternate Functions of Port E” on page 77](#) and [“Clock Systems and their Distribution” on page 29](#).

4.2.7 AVCC

AVCC is the supply voltage pin for the A/D Converter. It should be externally connected to V_{CC} , even if the ADC is not used. If the ADC is used, it should be connected to V_{CC} through a low-pass filter.

4.2.8 AREF

This is the analog reference pin for the A/D Converter.

4.3 About Code Examples

This documentation contains simple code examples that briefly show how to use various parts of the device. These code examples assume that the part specific header file is included before compilation. Be aware that not all C compiler vendors include bit definitions in the header files and interrupt handling in C is compiler dependent. Please confirm with the C compiler documentation for more details.

5. Register Summary

Address	Name	Bit 7	Bit 6	Bit 5	Bit 4	Bit 3	Bit 2	Bit 1	Bit 0	Page
(0xFF)	PICR2H									page 170
(0xFE)	PICR2L									page 170
(0xFD)	PFRC2B	PCAE2B	PISEL2B	PELEV2B	PFLTE2B	PRFM2B3	PRFM2B2	PRFM2B1	PRFM2B0	page 169
(0xFC)	PFRC2A	PCAE2A	PISEL2A	PELEV2A	PFLTE2A	PRFM2A3	PRFM2A2	PRFM2A1	PRFM2A0	page 168
(0xFB)	PCTL2	PPRE21	PPRE20	PBFM2	PAOC2B	PAOC2A	PARUN2	PCCYC2	PRUN2	page 167
(0xFA)	PCNF2	PFIFTY2	PALOCK2	PLOCK2	PMODE21	PMODE20	POP2	PCLKSEL2	POME2	page 164
(0xF9)	OCR2RBH									page 164
(0xF8)	OCR2RBL									page 164
(0xF7)	OCR2SBH									page 163
(0xF6)	OCR2SBL									page 163
(0xF5)	OCR2RAH									page 163
(0xF4)	OCR2RAL									page 163
(0xF3)	OCR2SAH									page 163
(0xF2)	OCR2SAL									page 163
(0xF1)	POM2	POMV2B3	POMV2B2	POMV2B1	POMV2B0	POMV2A3	POMV2A2	POMV2A1	POMV2A0	page 171
(0xF0)	PSOC2	POS23	POS22	PSYNC21	PSYNC20	POEN2D	POEN2B	POEN2C	POEN2A	page 162
(0xEF)	PICR1H									page 170
(0xEE)	PICR1L									page 170
(0xED)	PFRC1B	PCAE1B	PISEL1B	PELEV1B	PFLTE1B	PRFM1B3	PRFM1B2	PRFM1B1	PRFM1B0	page 169
(0xEC)	PFRC1A	PCAE1A	PISEL1A	PELEV1A	PFLTE1A	PRFM1A3	PRFM1A2	PRFM1A1	PRFM1A0	page 168
(0xEB)	PCTL1	PPRE11	PPRE10	PBFM1	PAOC1B	PAOC1A	PARUN1	PCCYC1	PRUN1	page 166
(0xEA)	PCNF1	PFIFTY1	PALOCK1	PLOCK1	PMODE11	PMODE10	POP1	PCLKSEL1	-	page 164
(0xE9)	OCR1RBH									page 164
(0xE8)	OCR1RBL									page 164
(0xE7)	OCR1SBH									page 163
(0xE6)	OCR1SBL									page 163
(0xE5)	OCR1RAH									page 163
(0xE4)	OCR1RAL									page 163
(0xE3)	OCR1SAH									page 163
(0xE2)	OCR1SAL									page 163
(0xE1)	Reserved	-	-	-	-	-	-	-	-	
(0xE0)	PSOC1	-	-	PSYNC11	PSYNC10	-	POEN1B	-	POEN1A	page 162
(0xDF)	PICR0H									page 170
(0xDE)	PICR0L									page 170
(0xDD)	PFRC0B	PCAE0B	PISEL0B	PELEV0B	PFLTE0B	PRFM0B3	PRFM0B2	PRFM0B1	PRFM0B0	page 169
(0xDC)	PFRC0A	PCAE0A	PISEL0A	PELEV0A	PFLTE0A	PRFM0A3	PRFM0A2	PRFM0A1	PRFM0A0	page 168
(0xDB)	PCTL0	PPRE01	PPRE00	PBFM0	PAOC0B	PAOC0A	PARUN0	PCCYC0	PRUN0	page 165
(0xDA)	PCNF0	PFIFTY0	PALOCK0	PLOCK0	PMODE01	PMODE00	POP0	PCLKSEL0	-	page 164
(0xD9)	OCR0RBH									page 164
(0xD8)	OCR0RBL									page 164
(0xD7)	OCR0SBH									page 163
(0xD6)	OCR0SBL									page 163
(0xD5)	OCR0RAH									page 163
(0xD4)	OCR0RAL									page 163
(0xD3)	OCR0SAH									page 163
(0xD2)	OCR0SAL									page 163
(0xD1)	Reserved	-	-	-	-	-	-	-	-	
(0xD0)	PSOC0	-	-	PSYNC01	PSYNC00	-	POEN0B	-	POEN0A	page 162
(0xCF)	Reserved	-	-	-	-	-	-	-	-	
(0xCE)	EUDR	EUDR7	EUDR6	EUDR5	EUDR4	EUDR3	EUDR2	EUDR1	EUDR0	page 221
(0xCD)	MUBRRH	MUBRR15	MUBRR014	MUBRR13	MUBRR12	MUBRR011	MUBRR010	MUBRR9	MUBRR8	page 226
(0xCC)	MUBRRL	MUBRR7	MUBRR6	MUBRR5	MUBRR4	MUBRR3	MUBRR2	MUBRR1	MUBRR0	page 226
(0xCB)	Reserved	-	-	-	-	-	-	-	-	
(0xCA)	EUCSRC	-	-	-	-	FEM	F1617	STP1	STP0	page 225
(0xC9)	EUCSRB	-	-	-	EUSART	EUSBS	-	EMCH	BODR	page 224
(0xC8)	EUCSRA	UTxS3	UTxS2	UTxS1	UTxS0	URxS3	URxS2	URxS1	URxS0	page 223
(0xC7)	Reserved	-	-	-	-	-	-	-	-	
(0xC6)	UDR	UDR07	UDR06	UDR05	UDR04	UDR03	UDR02	UDR01	UDR00	page 221 & page 202
(0xC5)	UBRRH	-	-	-	-	UBRR011	UBRR010	UBRR09	UBRR08	page 207
(0xC4)	UBRRL	UBRR07	UBRR06	UBRR05	UBRR04	UBRR03	UBRR02	UBRR01	UBRR00	page 207
(0xC3)	Reserved	-	-	-	-	-	-	-	-	
(0xC2)	UCSRC	-	UMSEL0	UPM01	UPM00	USBS0	UCSZ01	UCSZ00	UCPOL0	page 205
(0xC1)	UCSRB	RXCIE0	TXCIE0	UDRIE0	RXEN0	TXEN0	UCSZ02	RXB80	TXB80	page 204
(0xC0)	UCSRA	RXC0	TXC0	UDRE0	FE0	DOR0	UPE0	U2X0	MPCM0	page 203
(0xBF)	Reserved	-	-	-	-	-	-	-	-	

Address	Name	Bit 7	Bit 6	Bit 5	Bit 4	Bit 3	Bit 2	Bit 1	Bit 0	Page
(0xBE)	Reserved	-	-	-	-	-	-	-	-	
(0xBD)	Reserved	-	-	-	-	-	-	-	-	
(0xBC)	Reserved	-	-	-	-	-	-	-	-	
(0xBB)	Reserved	-	-	-	-	-	-	-	-	
(0xBA)	Reserved	-	-	-	-	-	-	-	-	
(0xB9)	Reserved	-	-	-	-	-	-	-	-	
(0xB8)	Reserved	-	-	-	-	-	-	-	-	
(0xB7)	Reserved	-	-	-	-	-	-	-	-	
(0xB6)	Reserved	-	-	-	-	-	-	-	-	
(0xB5)	Reserved	-	-	-	-	-	-	-	-	
(0xB4)	Reserved	-	-	-	-	-	-	-	-	
(0xB3)	Reserved	-	-	-	-	-	-	-	-	
(0xB2)	Reserved	-	-	-	-	-	-	-	-	
(0xB1)	Reserved	-	-	-	-	-	-	-	-	
(0xB0)	Reserved	-	-	-	-	-	-	-	-	
(0xAF)	AC2CON	AC2EN	AC2IE	AC2IS1	AC2IS0	AC2SADE-	AC2M2	AC2M1	AC2M0	page 230
(0xAE)	AC1CON	AC1EN	AC1IE	AC1IS1	AC1IS0	AC1ICE	AC1M2	AC1M1	AC1M0	page 229
(0xAD)	AC0CON	AC0EN	AC0IE	AC0IS1	AC0IS0	-	AC0M2	AC0M1	AC0M0	page 228
(0xAC)	DACH	- / DAC9	- / DAC8	- / DAC7	- / DAC6	- / DAC5	- / DAC4	DAC9 / DAC3	DAC8 / DAC2	page 262
(0xAB)	DAACL	DAC7 / DAC1	DAC6 / DAC0	DAC5 / -	DAC4 / -	DAC3 / -	DAC2 / -	DAC1 / -	DAC0 /	page 262
(0xAA)	DAACON	DAATE	DATS2	DATS1	DATS0	-	DALA	DAOE	DAEN	page 261
(0xA9)	Reserved	-	-	-	-	-	-	-	-	
(0xA8)	Reserved	-	-	-	-	-	-	-	-	
(0xA7)	Reserved	-	-	-	-	-	-	-	-	
(0xA6)	Reserved	-	-	-	-	-	-	-	-	
(0xA5)	PIM2	-	-	PSEIE2	PEVE2B	PEVE2A	-	-	PEOPE2	page 172
(0xA4)	PIFR2	-	-	PSEIE2	PEV2B	PEV2A	PRN21	PRN20	PEOP2	page 172
(0xA3)	PIM1	-	-	PSEIE1	PEVE1B	PEVE1A	-	-	PEOPE1	page 171
(0xA2)	PIFR1	-	-	PSEIE1	PEV1B	PEV1A	PRN11	PRN10	PEOP1	page 172
(0xA1)	PIM0	-	-	PSEIE0	PEVE0B	PEVE0A	-	-	PEOPE0	page 171
(0xA0)	PIFR0	-	-	PSEIE0	PEV0B	PEV0A	PRN01	PRN00	PEOP0	page 172
(0x9F)	Reserved	-	-	-	-	-	-	-	-	
(0x9E)	Reserved	-	-	-	-	-	-	-	-	
(0x9D)	Reserved	-	-	-	-	-	-	-	-	
(0x9C)	Reserved	-	-	-	-	-	-	-	-	
(0x9B)	Reserved	-	-	-	-	-	-	-	-	
(0x9A)	Reserved	-	-	-	-	-	-	-	-	
(0x99)	Reserved	-	-	-	-	-	-	-	-	
(0x98)	Reserved	-	-	-	-	-	-	-	-	
(0x97)	Reserved	-	-	-	-	-	-	-	-	
(0x96)	Reserved	-	-	-	-	-	-	-	-	
(0x95)	Reserved	-	-	-	-	-	-	-	-	
(0x94)	Reserved	-	-	-	-	-	-	-	-	
(0x93)	Reserved	-	-	-	-	-	-	-	-	
(0x92)	Reserved	-	-	-	-	-	-	-	-	
(0x91)	Reserved	-	-	-	-	-	-	-	-	
(0x90)	Reserved	-	-	-	-	-	-	-	-	
(0x8F)	Reserved	-	-	-	-	-	-	-	-	
(0x8E)	Reserved	-	-	-	-	-	-	-	-	
(0x8D)	Reserved	-	-	-	-	-	-	-	-	
(0x8C)	Reserved	-	-	-	-	-	-	-	-	
(0x8B)	OCR1BH	OCR1B15	OCR1B14	OCR1B13	OCR1B12	OCR1B11	OCR1B10	OCR1B9	OCR1B8	page 127
(0x8A)	OCR1BL	OCR1B7	OCR1B6	OCR1B5	OCR1B4	OCR1B3	OCR1B2	OCR1B1	OCR1B0	page 127
(0x89)	OCR1AH	OCR1A15	OCR1A14	OCR1A13	OCR1A12	OCR1A11	OCR1A10	OCR1A9	OCR1A8	page 127
(0x88)	OCR1AL	OCR1A7	OCR1A6	OCR1A5	OCR1A4	OCR1A3	OCR1A2	OCR1A1	OCR1A0	page 127
(0x87)	ICR1H	ICR115	ICR114	ICR113	ICR112	ICR111	ICR110	ICR19	ICR18	page 128
(0x86)	ICR1L	ICR17	ICR16	ICR15	ICR14	ICR13	ICR12	ICR11	ICR10	page 128
(0x85)	TCNT1H	TCNT115	TCNT114	TCNT113	TCNT112	TCNT111	TCNT110	TCNT19	TCNT18	page 127
(0x84)	TCNT1L	TCNT17	TCNT16	TCNT15	TCNT14	TCNT13	TCNT12	TCNT11	TCNT10	page 127
(0x83)	Reserved	-	-	-	-	-	-	-	-	
(0x82)	TCCR1C	FOC1A	FOC1B	-	-	-	-	-	-	page 127
(0x81)	TCCR1B	ICNC1	ICES1	-	WGM13	WGM12	CS12	CS11	CS10	page 126
(0x80)	TCCR1A	COM1A1	COM1A0	COM1B1	COM1B0	-	-	WGM11	WGM10	page 123
(0x7F)	DIDR1	-	-	ACMP0D	AMP0PD	AMP0ND	ADC10D/ACMP1D	ADC9D/AMP1PD	ADC8D/AMP1ND	page 252
(0x7E)	DIDR0	ADC7D	ADC6D	ADC5D	ADC4D	ADC3D/ACMPMD	ADC2D/ACMP2D	ADC1D	ADC0D	page 251
(0x7D)	Reserved	-	-	-	-	-	-	-	-	



Address	Name	Bit 7	Bit 6	Bit 5	Bit 4	Bit 3	Bit 2	Bit 1	Bit 0	Page
(0x7C)	ADMUX	REFS1	REFS0	ADLAR	–	MUX3	MUX2	MUX1	MUX0	page 247
(0x7B)	ADCSRB	ADHSM	–	–	ADASCR	ADTS3	ADTS2	ADTS1	ADTS0	page 249
(0x7A)	ADCSRA	ADEN	ADSC	ADATE	ADIF	ADIE	ADPS2	ADPS1	ADPS0	page 248
(0x79)	ADCH	- / ADC9	- / ADC8	- / ADC7	- / ADC6	- / ADC5	- / ADC4	ADC9 / ADC3	ADC8 / ADC2	page 251
(0x78)	ADCL	ADC7 / ADC1	ADC6 / ADC0	ADC5 / -	ADC4 / -	ADC3 / -	ADC2 / -	ADC1 / -	ADC0 / -	page 251
(0x77)	AMP1CSR	AMP1EN	-	AMP1G1	AMP1G0	-	AMP1TS2	AMP1TS1	AMP1TS0	page 257
(0x76)	AMPOCSR	AMPOEN	-	AMPOG1	AMPOG0	-	AMPOTS2	AMPOTS1	AMPOTS0	page 256
(0x75)	Reserved	–	–	–	–	–	–	–	–	
(0x74)	Reserved	–	–	–	–	–	–	–	–	
(0x73)	Reserved	–	–	–	–	–	–	–	–	
(0x72)	Reserved	–	–	–	–	–	–	–	–	
(0x71)	Reserved	–	–	–	–	–	–	–	–	
(0x70)	Reserved	–	–	–	–	–	–	–	–	
(0x6F)	TIMSK1	–	–	ICIE1	–	–	OCIE1B	OCIE1A	TOIE1	page 128
(0x6E)	TIMSK0	–	–	–	–	–	OCIE0B	OCIE0A	TOIE0	page 101
(0x6D)	Reserved	–	–	–	–	–	–	–	–	
(0x6C)	Reserved	–	–	–	–	–	–	–	–	
(0x6B)	Reserved	–	–	–	–	–	–	–	–	
(0x6A)	Reserved	–	–	–	–	–	–	–	–	
(0x69)	EICRA	ISC31	ISC30	ISC21	ISC20	ISC11	ISC10	ISC01	ISC00	page 81
(0x68)	Reserved	–	–	–	–	–	–	–	–	
(0x67)	Reserved	–	–	–	–	–	–	–	–	
(0x66)	OSCCAL	–	CAL6	CAL5	CAL4	CAL3	CAL2	CAL1	CAL0	page 34
(0x65)	Reserved	–	–	–	–	–	–	–	–	
(0x64)	PRR	PRPSC2	PRPSC1	PRPSC0	PRTIM1	PRTIM0	PRSPI	PRUSART	PRADC	page 43
(0x63)	Reserved	–	–	–	–	–	–	–	–	
(0x62)	Reserved	–	–	–	–	–	–	–	–	
(0x61)	CLKPR	CLKPCE	–	–	–	CLKPS3	CLKPS2	CLKPS1	CLKPS0	page 39
(0x60)	WDTCR	WDIF	WDIE	WDP3	WDCE	WDE	WDP2	WDP1	WDP0	page 54
0x3F (0x5F)	SREG	I	T	H	S	V	N	Z	C	page 13
0x3E (0x5E)	SPH	SP15	SP14	SP13	SP12	SP11	SP10	SP9	SP8	page 15
0x3D (0x5D)	SPL	SP7	SP6	SP5	SP4	SP3	SP2	SP1	SP0	page 15
0x3C (0x5C)	Reserved	–	–	–	–	–	–	–	–	
0x3B (0x5B)	Reserved	–	–	–	–	–	–	–	–	
0x3A (0x5A)	Reserved	–	–	–	–	–	–	–	–	
0x39 (0x59)	Reserved	–	–	–	–	–	–	–	–	
0x38 (0x58)	Reserved	–	–	–	–	–	–	–	–	
0x37 (0x57)	SPMCSR	SPMIE	RWWSB	–	RWWSRE	BLBSET	PGWRT	PGERS	SPMEN	page 271
0x36 (0x56)	Reserved	–	–	–	–	–	–	–	–	
0x35 (0x55)	MCUCR	SPIPS	–	–	PUD	–	–	IVSEL	IVCE	page 60 & page 68
0x34 (0x54)	MCUSR	–	–	–	–	WDRF	BORF	EXTRF	PORF	page 50
0x33 (0x53)	SMCR	–	–	–	–	SM2	SM1	SM0	SE	page 41
0x32 (0x52)	MSMCR	Monitor Stop Mode Control Register								reserved
0x31 (0x51)	MONDR	Monitor Data Register								reserved
0x30 (0x50)	ACSR	ACCKDIV	AC2IF	AC1IF	AC0IF	–	AC2O	AC1O	AC0O	page 231
0x2F (0x4F)	Reserved	–	–	–	–	–	–	–	–	
0x2E (0x4E)	SPDR	SPD7	SPD6	SPD5	SPD4	SPD3	SPD2	SPD1	SPD0	page 181
0x2D (0x4D)	SPSR	SPIF	WCOL	–	–	–	–	–	SPI2X	page 181
0x2C (0x4C)	SPCR	SPIE	SPE	DORD	MSTR	CPOL	CPHA	SPR1	SPR0	page 179
0x2B (0x4B)	Reserved	–	–	–	–	–	–	–	–	
0x2A (0x4A)	Reserved	–	–	–	–	–	–	–	–	
0x29 (0x49)	PLLCSR	–	–	–	–	–	PLLF	PLLE	PLOCK	page 37
0x28 (0x48)	OCR0B	OCR0B7	OCR0B6	OCR0B5	OCR0B4	OCR0B3	OCR0B2	OCR0B1	OCR0B0	page 101
0x27 (0x47)	OCR0A	OCR0A7	OCR0A6	OCR0A5	OCR0A4	OCR0A3	OCR0A2	OCR0A1	OCR0A0	page 100
0x26 (0x46)	TCNT0	TCNT07	TCNT06	TCNT05	TCNT04	TCNT03	TCNT02	TCNT01	TCNT00	page 100
0x25 (0x45)	TCCR0B	FOCOA	FOC0B	–	–	WGM02	CS02	CS01	CS00	page 99
0x24 (0x44)	TCCR0A	COM0A1	COM0A0	COM0B1	COM0B0	–	–	WGM01	WGM00	page 96
0x23 (0x43)	GTCCR	TSM	ICPSEL1	–	–	–	–	–	PSRSYNC	page 84
0x22 (0x42)	EEARH	–	–	–	–	EEAR11	EEAR10	EEAR9	EEAR8	page 21
0x21 (0x41)	EEARL	EEAR7	EEAR6	EEAR5	EEAR4	EEAR3	EEAR2	EEAR1	EEAR0	page 21
0x20 (0x40)	EEDR	EEDR7	EEDR6	EEDR5	EEDR4	EEDR3	EEDR2	EEDR1	EEDR0	page 22
0x1F (0x3F)	EEDR	–	–	–	–	–	EEMWE	EERE	EERE	page 22
0x1E (0x3E)	GPOR0	GPOR07	GPOR06	GPOR05	GPOR04	GPOR03	GPOR02	GPOR01	GPOR00	page 27
0x1D (0x3D)	EIMSK	–	–	–	–	INT3	INT2	INT1	INT0	page 82
0x1C (0x3C)	EIFR	–	–	–	–	INTF3	INTF2	INTF1	INTF0	page 82
0x1B (0x3B)	GPOR3	GPOR37	GPOR36	GPOR35	GPOR34	GPOR33	GPOR32	GPOR31	GPOR30	page 28

Address	Name	Bit 7	Bit 6	Bit 5	Bit 4	Bit 3	Bit 2	Bit 1	Bit 0	Page
0x1A (0x3A)	GPIOR2	GPIOR27	GPIOR26	GPIOR25	GPIOR24	GPIOR23	GPIOR22	GPIOR21	GPIOR20	page 27
0x19 (0x39)	GPIOR1	GPIOR17	GPIOR16	GPIOR15	GPIOR14	GPIOR13	GPIOR12	GPIOR11	GPIOR10	page 27
0x18 (0x38)	Reserved	–	–	–	–	–	–	–	–	
0x17 (0x37)	Reserved	–	–	–	–	–	–	–	–	
0x16 (0x36)	TIFR1	–	–	ICF1	–	–	OCF1B	OCF1A	TOV1	page 129
0x15 (0x35)	TIFR0	–	–	–	–	–	OCF0B	OCF0A	TOV0	page 101
0x14 (0x34)	Reserved	–	–	–	–	–	–	–	–	
0x13 (0x33)	Reserved	–	–	–	–	–	–	–	–	
0x12 (0x32)	Reserved	–	–	–	–	–	–	–	–	
0x11 (0x31)	Reserved	–	–	–	–	–	–	–	–	
0x10 (0x30)	Reserved	–	–	–	–	–	–	–	–	
0x0F (0x2F)	Reserved	–	–	–	–	–	–	–	–	
0x0E (0x2E)	PORTE	–	–	–	–	–	PORTE2	PORTE1	PORTE0	page 79
0x0D (0x2D)	DDRE	–	–	–	–	–	DDE2	DDE1	DDE0	page 80
0x0C (0x2C)	PINE	–	–	–	–	–	PINE2	PINE1	PINE0	page 80
0x0B (0x2B)	PORTD	PORTD7	PORTD6	PORTD5	PORTD4	PORTD3	PORTD2	PORTD1	PORTD0	page 79
0x0A (0x2A)	DDRD	DDD7	DDD6	DDD5	DDD4	DDD3	DDD2	DDD1	DDD0	page 79
0x09 (0x29)	PIND	PIND7	PIND6	PIND5	PIND4	PIND3	PIND2	PIND1	PIND0	page 79
0x08 (0x28)	PORTC	PORTC7	PORTC6	PORTC5	PORTC4	PORTC3	PORTC2	PORTC1	PORTC0	page 79
0x07 (0x27)	DDRC	DDC7	DDC6	DDC5	DDC4	DDC3	DDC2	DDC1	DDC0	page 79
0x06 (0x26)	PINC	PINC7	PINC6	PINC5	PINC4	PINC3	PINC2	PINC1	PINC0	page 79
0x05 (0x25)	PORTB	PORTB7	PORTB6	PORTB5	PORTB4	PORTB3	PORTB2	PORTB1	PORTB0	page 78
0x04 (0x24)	DDRB	DDB7	DDB6	DDB5	DDB4	DDB3	DDB2	DDB1	DDB0	page 78
0x03 (0x23)	PINB	PINB7	PINB6	PINB5	PINB4	PINB3	PINB2	PINB1	PINB0	page 79
0x02 (0x22)	Reserved	–	–	–	–	–	–	–	–	
0x01 (0x21)	Reserved	–	–	–	–	–	–	–	–	
0x00 (0x20)	Reserved	–	–	–	–	–	–	–	–	

- Note:
- For compatibility with future devices, reserved bits should be written to zero if accessed. Reserved I/O memory addresses should never be written.
 - I/O Registers within the address range 0x00 - 0x1F are directly bit-accessible using the SBI and CBI instructions. In these registers, the value of single bits can be checked by using the SBIS and SBIC instructions.
 - Some of the status flags are cleared by writing a logical one to them. Note that, unlike most other AVRs, the CBI and SBI instructions will only operate on the specified bit, and can therefore be used on registers containing such status flags. The CBI and SBI instructions work with registers 0x00 to 0x1F only.
 - When using the I/O specific commands IN and OUT, the I/O addresses 0x00 - 0x3F must be used. When addressing I/O Registers as data space using LD and ST instructions, 0x20 must be added to these addresses. The AT90PWM2/2B/3/3B is a complex microcontroller with more peripheral units than can be supported within the 64 location reserved in Opcode for the IN and OUT instructions. For the Extended I/O space from 0x60 - 0xFF in SRAM, only the ST/STS/STD and LD/LDS/LDD instructions can be used.

6. Instruction Set Summary

Mnemonics	Operands	Description	Operation	Flags	#Clocks
ARITHMETIC AND LOGIC INSTRUCTIONS					
ADD	Rd, Rr	Add two Registers	$Rd \leftarrow Rd + Rr$	Z,C,N,V,H	1
ADC	Rd, Rr	Add with Carry two Registers	$Rd \leftarrow Rd + Rr + C$	Z,C,N,V,H	1
ADIW	Rdl,K	Add Immediate to Word	$Rdh:Rdl \leftarrow Rdh:Rdl + K$	Z,C,N,V,S	2
SUB	Rd, Rr	Subtract two Registers	$Rd \leftarrow Rd - Rr$	Z,C,N,V,H	1
SUBI	Rd, K	Subtract Constant from Register	$Rd \leftarrow Rd - K$	Z,C,N,V,H	1
SBC	Rd, Rr	Subtract with Carry two Registers	$Rd \leftarrow Rd - Rr - C$	Z,C,N,V,H	1
SBCI	Rd, K	Subtract with Carry Constant from Reg.	$Rd \leftarrow Rd - K - C$	Z,C,N,V,H	1
SBIW	Rdl,K	Subtract Immediate from Word	$Rdh:Rdl \leftarrow Rdh:Rdl - K$	Z,C,N,V,S	2
AND	Rd, Rr	Logical AND Registers	$Rd \leftarrow Rd \cdot Rr$	Z,N,V	1
ANDI	Rd, K	Logical AND Register and Constant	$Rd \leftarrow Rd \cdot K$	Z,N,V	1
OR	Rd, Rr	Logical OR Registers	$Rd \leftarrow Rd \vee Rr$	Z,N,V	1
ORI	Rd, K	Logical OR Register and Constant	$Rd \leftarrow Rd \vee K$	Z,N,V	1
EOR	Rd, Rr	Exclusive OR Registers	$Rd \leftarrow Rd \oplus Rr$	Z,N,V	1
COM	Rd	One's Complement	$Rd \leftarrow 0xFF - Rd$	Z,C,N,V	1
NEG	Rd	Two's Complement	$Rd \leftarrow 0x00 - Rd$	Z,C,N,V,H	1
SBR	Rd,K	Set Bit(s) in Register	$Rd \leftarrow Rd \vee K$	Z,N,V	1
CBR	Rd,K	Clear Bit(s) in Register	$Rd \leftarrow Rd \cdot (0xFF - K)$	Z,N,V	1
INC	Rd	Increment	$Rd \leftarrow Rd + 1$	Z,N,V	1
DEC	Rd	Decrement	$Rd \leftarrow Rd - 1$	Z,N,V	1
TST	Rd	Test for Zero or Minus	$Rd \leftarrow Rd \cdot Rd$	Z,N,V	1
CLR	Rd	Clear Register	$Rd \leftarrow Rd \oplus Rd$	Z,N,V	1
SER	Rd	Set Register	$Rd \leftarrow 0xFF$	None	1
MUL	Rd, Rr	Multiply Unsigned	$R1:R0 \leftarrow Rd \times Rr$	Z,C	2
MULS	Rd, Rr	Multiply Signed	$R1:R0 \leftarrow Rd \times Rr$	Z,C	2
MULSU	Rd, Rr	Multiply Signed with Unsigned	$R1:R0 \leftarrow Rd \times Rr$	Z,C	2
FMUL	Rd, Rr	Fractional Multiply Unsigned	$R1:R0 \leftarrow (Rd \times Rr) \ll 1$	Z,C	2
FMULS	Rd, Rr	Fractional Multiply Signed	$R1:R0 \leftarrow (Rd \times Rr) \ll 1$	Z,C	2
FMULSU	Rd, Rr	Fractional Multiply Signed with Unsigned	$R1:R0 \leftarrow (Rd \times Rr) \ll 1$	Z,C	2
BRANCH INSTRUCTIONS					
RJMP	k	Relative Jump	$PC \leftarrow PC + k + 1$	None	2
IJMP		Indirect Jump to (Z)	$PC \leftarrow Z$	None	2
RCALL	k	Relative Subroutine Call	$PC \leftarrow PC + k + 1$	None	3
ICALL		Indirect Call to (Z)	$PC \leftarrow Z$	None	3
RET		Subroutine Return	$PC \leftarrow STACK$	None	4
RETI		Interrupt Return	$PC \leftarrow STACK$	I	4
CPSE	Rd,Rr	Compare, Skip if Equal	if (Rd = Rr) $PC \leftarrow PC + 2$ or 3	None	1/2/3
CP	Rd,Rr	Compare	$Rd - Rr$	Z, N, V, C, H	1
CPC	Rd,Rr	Compare with Carry	$Rd - Rr - C$	Z, N, V, C, H	1
CPI	Rd,K	Compare Register with Immediate	$Rd - K$	Z, N, V, C, H	1
SBRC	Rr, b	Skip if Bit in Register Cleared	if (Rr(b)=0) $PC \leftarrow PC + 2$ or 3	None	1/2/3
SBRS	Rr, b	Skip if Bit in Register is Set	if (Rr(b)=1) $PC \leftarrow PC + 2$ or 3	None	1/2/3
SBIC	P, b	Skip if Bit in I/O Register Cleared	if (P(b)=0) $PC \leftarrow PC + 2$ or 3	None	1/2/3
SBIS	P, b	Skip if Bit in I/O Register is Set	if (P(b)=1) $PC \leftarrow PC + 2$ or 3	None	1/2/3
BRBS	s, k	Branch if Status Flag Set	if (SREG(s) = 1) then $PC \leftarrow PC + k + 1$	None	1/2
BRBC	s, k	Branch if Status Flag Cleared	if (SREG(s) = 0) then $PC \leftarrow PC + k + 1$	None	1/2
BREQ	k	Branch if Equal	if (Z = 1) then $PC \leftarrow PC + k + 1$	None	1/2
BRNE	k	Branch if Not Equal	if (Z = 0) then $PC \leftarrow PC + k + 1$	None	1/2
BRCS	k	Branch if Carry Set	if (C = 1) then $PC \leftarrow PC + k + 1$	None	1/2
BRCC	k	Branch if Carry Cleared	if (C = 0) then $PC \leftarrow PC + k + 1$	None	1/2
BRSH	k	Branch if Same or Higher	if (C = 0) then $PC \leftarrow PC + k + 1$	None	1/2
BRLO	k	Branch if Lower	if (C = 1) then $PC \leftarrow PC + k + 1$	None	1/2
BRMI	k	Branch if Minus	if (N = 1) then $PC \leftarrow PC + k + 1$	None	1/2
BRPL	k	Branch if Plus	if (N = 0) then $PC \leftarrow PC + k + 1$	None	1/2
BRGE	k	Branch if Greater or Equal, Signed	if (N \oplus V = 0) then $PC \leftarrow PC + k + 1$	None	1/2
BRLT	k	Branch if Less Than Zero, Signed	if (N \oplus V = 1) then $PC \leftarrow PC + k + 1$	None	1/2
BRHS	k	Branch if Half Carry Flag Set	if (H = 1) then $PC \leftarrow PC + k + 1$	None	1/2
BRHC	k	Branch if Half Carry Flag Cleared	if (H = 0) then $PC \leftarrow PC + k + 1$	None	1/2
BRTS	k	Branch if T Flag Set	if (T = 1) then $PC \leftarrow PC + k + 1$	None	1/2
BRTC	k	Branch if T Flag Cleared	if (T = 0) then $PC \leftarrow PC + k + 1$	None	1/2
BRVS	k	Branch if Overflow Flag is Set	if (V = 1) then $PC \leftarrow PC + k + 1$	None	1/2
BRVC	k	Branch if Overflow Flag is Cleared	if (V = 0) then $PC \leftarrow PC + k + 1$	None	1/2
BRIE	k	Branch if Interrupt Enabled	if (I = 1) then $PC \leftarrow PC + k + 1$	None	1/2
BRID	k	Branch if Interrupt Disabled	if (I = 0) then $PC \leftarrow PC + k + 1$	None	1/2

Mnemonics	Operands	Description	Operation	Flags	#Clocks
BIT AND BIT-TEST INSTRUCTIONS					
SBI	P,b	Set Bit in I/O Register	$I/O(P,b) \leftarrow 1$	None	2
CBI	P,b	Clear Bit in I/O Register	$I/O(P,b) \leftarrow 0$	None	2
LSL	Rd	Logical Shift Left	$Rd(n+1) \leftarrow Rd(n), Rd(0) \leftarrow 0$	Z,C,N,V	1
LSR	Rd	Logical Shift Right	$Rd(n) \leftarrow Rd(n+1), Rd(7) \leftarrow 0$	Z,C,N,V	1
ROL	Rd	Rotate Left Through Carry	$Rd(0) \leftarrow C, Rd(n+1) \leftarrow Rd(n), C \leftarrow Rd(7)$	Z,C,N,V	1
ROR	Rd	Rotate Right Through Carry	$Rd(7) \leftarrow C, Rd(n) \leftarrow Rd(n+1), C \leftarrow Rd(0)$	Z,C,N,V	1
ASR	Rd	Arithmetic Shift Right	$Rd(n) \leftarrow Rd(n+1), n=0..6$	Z,C,N,V	1
SWAP	Rd	Swap Nibbles	$Rd(3..0) \leftarrow Rd(7..4), Rd(7..4) \leftarrow Rd(3..0)$	None	1
BSET	s	Flag Set	$SREG(s) \leftarrow 1$	SREG(s)	1
BCLR	s	Flag Clear	$SREG(s) \leftarrow 0$	SREG(s)	1
BST	Rr, b	Bit Store from Register to T	$T \leftarrow Rr(b)$	T	1
BLD	Rd, b	Bit load from T to Register	$Rd(b) \leftarrow T$	None	1
SEC		Set Carry	$C \leftarrow 1$	C	1
CLC		Clear Carry	$C \leftarrow 0$	C	1
SEN		Set Negative Flag	$N \leftarrow 1$	N	1
CLN		Clear Negative Flag	$N \leftarrow 0$	N	1
SEZ		Set Zero Flag	$Z \leftarrow 1$	Z	1
CLZ		Clear Zero Flag	$Z \leftarrow 0$	Z	1
SEI		Global Interrupt Enable	$I \leftarrow 1$	I	1
CLI		Global Interrupt Disable	$I \leftarrow 0$	I	1
SES		Set Signed Test Flag	$S \leftarrow 1$	S	1
CLS		Clear Signed Test Flag	$S \leftarrow 0$	S	1
SEV		Set Twos Complement Overflow	$V \leftarrow 1$	V	1
CLV		Clear Twos Complement Overflow	$V \leftarrow 0$	V	1
SET		Set T in SREG	$T \leftarrow 1$	T	1
CLT		Clear T in SREG	$T \leftarrow 0$	T	1
SEH		Set Half Carry Flag in SREG	$H \leftarrow 1$	H	1
CLH		Clear Half Carry Flag in SREG	$H \leftarrow 0$	H	1
DATA TRANSFER INSTRUCTIONS					
MOV	Rd, Rr	Move Between Registers	$Rd \leftarrow Rr$	None	1
MOVW	Rd, Rr	Copy Register Word	$Rd+1:Rd \leftarrow Rr+1:Rr$	None	1
LDI	Rd, K	Load Immediate	$Rd \leftarrow K$	None	1
LD	Rd, X	Load Indirect	$Rd \leftarrow (X)$	None	2
LD	Rd, X+	Load Indirect and Post-Inc.	$Rd \leftarrow (X), X \leftarrow X + 1$	None	2
LD	Rd, -X	Load Indirect and Pre-Dec.	$X \leftarrow X - 1, Rd \leftarrow (X)$	None	2
LD	Rd, Y	Load Indirect	$Rd \leftarrow (Y)$	None	2
LD	Rd, Y+	Load Indirect and Post-Inc.	$Rd \leftarrow (Y), Y \leftarrow Y + 1$	None	2
LD	Rd, -Y	Load Indirect and Pre-Dec.	$Y \leftarrow Y - 1, Rd \leftarrow (Y)$	None	2
LDD	Rd, Y+q	Load Indirect with Displacement	$Rd \leftarrow (Y + q)$	None	2
LD	Rd, Z	Load Indirect	$Rd \leftarrow (Z)$	None	2
LD	Rd, Z+	Load Indirect and Post-Inc.	$Rd \leftarrow (Z), Z \leftarrow Z + 1$	None	2
LD	Rd, -Z	Load Indirect and Pre-Dec.	$Z \leftarrow Z - 1, Rd \leftarrow (Z)$	None	2
LDD	Rd, Z+q	Load Indirect with Displacement	$Rd \leftarrow (Z + q)$	None	2
LDS	Rd, k	Load Direct from SRAM	$Rd \leftarrow (k)$	None	2
ST	X, Rr	Store Indirect	$(X) \leftarrow Rr$	None	2
ST	X+, Rr	Store Indirect and Post-Inc.	$(X) \leftarrow Rr, X \leftarrow X + 1$	None	2
ST	-X, Rr	Store Indirect and Pre-Dec.	$X \leftarrow X - 1, (X) \leftarrow Rr$	None	2
ST	Y, Rr	Store Indirect	$(Y) \leftarrow Rr$	None	2
ST	Y+, Rr	Store Indirect and Post-Inc.	$(Y) \leftarrow Rr, Y \leftarrow Y + 1$	None	2
ST	-Y, Rr	Store Indirect and Pre-Dec.	$Y \leftarrow Y - 1, (Y) \leftarrow Rr$	None	2
STD	Y+q, Rr	Store Indirect with Displacement	$(Y + q) \leftarrow Rr$	None	2
ST	Z, Rr	Store Indirect	$(Z) \leftarrow Rr$	None	2
ST	Z+, Rr	Store Indirect and Post-Inc.	$(Z) \leftarrow Rr, Z \leftarrow Z + 1$	None	2
ST	-Z, Rr	Store Indirect and Pre-Dec.	$Z \leftarrow Z - 1, (Z) \leftarrow Rr$	None	2
STD	Z+q, Rr	Store Indirect with Displacement	$(Z + q) \leftarrow Rr$	None	2
STS	k, Rr	Store Direct to SRAM	$(k) \leftarrow Rr$	None	2
LPM		Load Program Memory	$R0 \leftarrow (Z)$	None	3
LPM	Rd, Z	Load Program Memory	$Rd \leftarrow (Z)$	None	3
LPM	Rd, Z+	Load Program Memory and Post-Inc	$Rd \leftarrow (Z), Z \leftarrow Z + 1$	None	3
SPM		Store Program Memory	$(Z) \leftarrow R1:R0$	None	-
IN	Rd, P	In Port	$Rd \leftarrow P$	None	1
OUT	P, Rr	Out Port	$P \leftarrow Rr$	None	1
PUSH	Rr	Push Register on Stack	$STACK \leftarrow Rr$	None	2
POP	Rd	Pop Register from Stack	$Rd \leftarrow STACK$	None	2
MCU CONTROL INSTRUCTIONS					



Mnemonics	Operands	Description	Operation	Flags	#Clocks
NOP		No Operation		None	1
SLEEP		Sleep	(see specific descr. for Sleep function)	None	1
WDR		Watchdog Reset	(see specific descr. for WDR/timer)	None	1
BREAK		Break	For On-chip Debug Only	None	N/A



7. Ordering Information

Speed (MHz)	Power Supply	Ordering Code	Package	Operation Range
16	2.7 - 5.5V	AT90PWM3-16SQ	SO32	Extended (-40°C to 105°C)
16	2.7 - 5.5V	AT90PWM3-16MQT	QFN32	Extended (-40°C to 105°C)
16	2.7 - 5.5V	AT90PWM2-16SQ	SO24	Extended (-40°C to 105°C)
16	2.7 - 5.5V	AT90PWM3B-16SE	SO32	Engineering Samples
16	2.7 - 5.5V	AT90PWM3B-16ME	QFN32	Engineering Samples
16	2.7 - 5.5V	AT90PWM2B-16SE	SO24	Engineering Samples
16	2.7 - 5.5V	AT90PWM3B-16SU	SO32	Extended (-40°C to 105°C)
16	2.7 - 5.5V	AT90PWM3B-16MU	QFN32	Extended (-40°C to 105°C)
16	2.7 - 5.5V	AT90PWM2B-16SU	SO24	Extended (-40°C to 105°C)

Note: All packages are Pb free, fully LHF

Note: This device can also be supplied in wafer form. Please contact your local Atmel sales office for detailed ordering information and minimum quantities.

Note: Parts numbers are for shipping in sticks (SO) or in trays (QFN). These devices can also be supplied in Tape and Reel. Please contact your local Atmel sales office for detailed ordering information and minimum quantities.

Note: PWM2 is not recommended for new designs, use PWM2B for your developments

Note: PWM3 is not recommended for new designs, use PWM3B for your developments



8. Package Information

Package Type	
SO24	24-Lead, Small Outline Package
SO32	32-Lead, Small Outline Package
QFN32	32-Lead, Quad Flat No lead



8.1 SO24

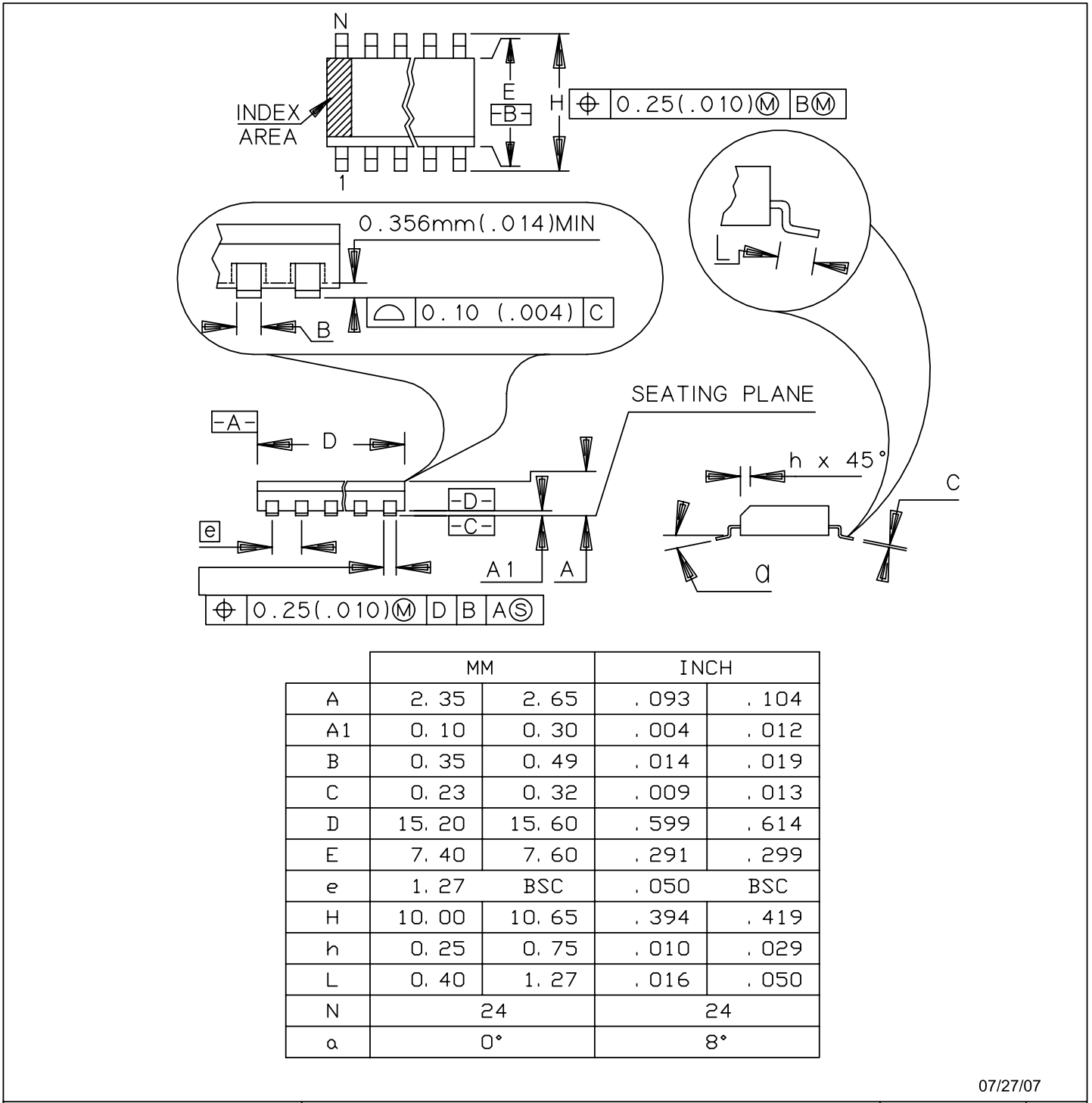

07/27/07

ATMEL Atmel Nantes S.A.
La Chantrerie - BP 70602
44306 Nantes Cedex 3 - France

TITLE
TD, 24 - Lead, 0.300" Body Width
Plastic Gull Wing Small Outline Package (SOIC)

DRAWING No.	REV.
TD	A

8.2 SO32

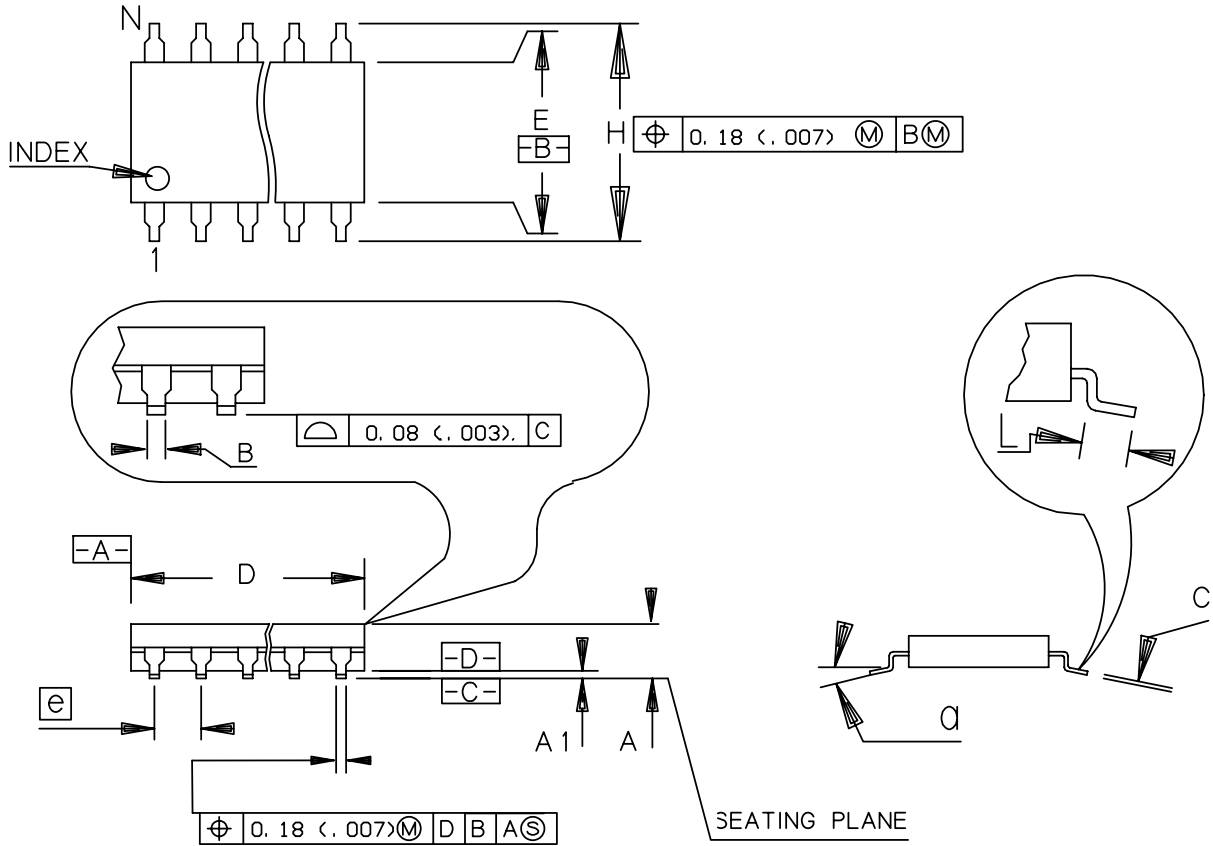

	MM		INCH	
	Min	Max	Min	Max
A	2.29	2.54	.090	.100
A1	0.10	0.25	.004	.010
B	0.36	0.51	.014	.020
C	0.15	0.32	.006	.013
D	20.57	20.88	.810	.822
E	7.42	7.60	.292	.299
e	1.27	BSC	.050	BSC
H	10.29	10.64	.405	.419
L	0.53	1.04	.021	.041
N	32		32	
α	4°		4°	

07/27/07

8.3 QFN32

32 LEADS MicroLEADFRAME

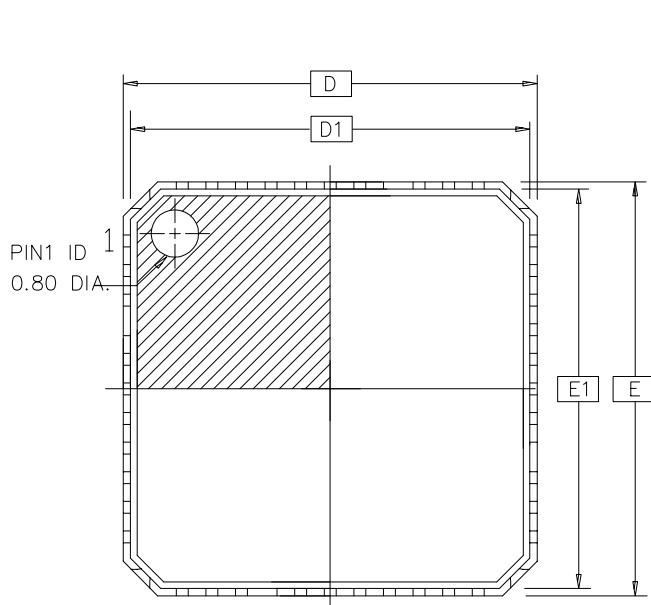

TOP VIEW

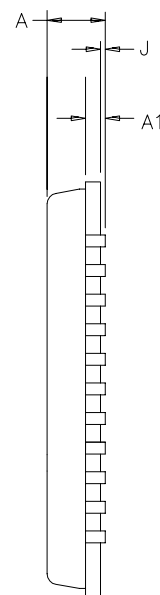

SIDE VIEW

DRAWINGS NOT SCALED

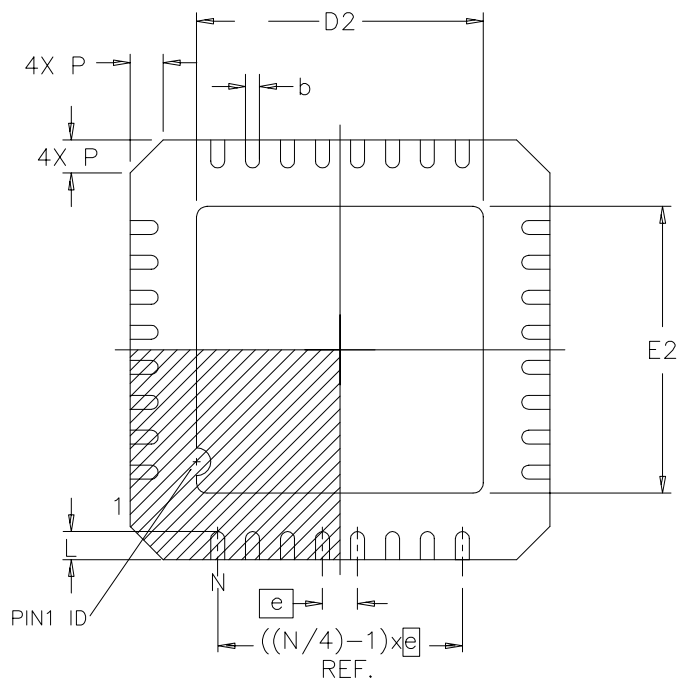

	MM			INCH		
	MIN	NOM	MAX	MIN	NOM	MAX
A	0.80	-	1.00	.032	-	.040
J	0.00	0.01	0.05	.000	.000	.002
A1	0.20 ref			.008 ref		
D/E	7.00 BSC			.276 BSC		
D1/E1	6.75 BSC			.266 BSC		
D2/E2	2.25	-	5.25	.090	-	.207
N	32					
P	0.24	0.42	0.60	.009	.016	.024
e	0.65 BSC			.026 BSC		
L	0.35	-	0.75	.014	-	.030
b	0.23	-	0.35	.009	-	.014

NOTES: MLF PACKAGE FAMILY

1. DIE THICKNESS ALLOWABLE IS 0.305mm MAXIMUM(.012 INCHES MAXIMUM)
2. DIMENSIONING & TOLERANCES CONFORM TO ASME Y14.5M. – 1994.
- 3 DIMENSION b APPLIES TO PLATED TERMINAL AND IS MEASURED
BETWEEN 0.20 AND 0.25mm FROM TERMINAL TIP.
- 4 PACKAGE WARPAGE MAX 0.08mm.
- 5 THE PIN #1 IDENTIFIER MUST BE EXISTED ON THE TOP SURFACE OF THE
PACKAGE BY USING INDENTATION MARK OR OTHER FEATURE OF PACKAGE BODY.
- 6 EXACT SHAPE AND SIZE OF THIS FIXTURE IS OPTIONAL

9. Errata

9.1 AT90PWM2&3 Rev. A (Mask Revision)

- PGM: PSCxRB Fuse
- PSC: Prescaler
- PSC: PAOCnA and PAOCnB Register Bits (Asynchronous output control)
- PSC: PEVxA/B Flag Bits
- PSC: Output Polarity in Centered Mode
- PSC: Output Activity
- VREF
- DALI
- DAC: Register Update
- DAC: Output spikes
- DAC driver: Output Voltage linearity
- ADC: Conversion accuracy
- Analog comparator: Offset value
- Analog comparator: Output signal
- PSC: Autolock modes
- DALI: 17th bit detection
- PSC: One ramp mode with PSC input mode 8

1. PGM: PSCnRB Fuse

The use of PSCnRB fuse can make the parallel ISP fail.

Workaround:

When PSCnRB fuses are used, use the serial programming mode to load a new program version.

2. PSC: Prescaler

The use of PSC's prescaler have the following effects :

It blocks the sample of PSC inputs until the two first cycles following the set of PSC run bit.

A fault is not properly transferred to other (slave) PSC.

Workaround:

Clear the prescaler PPREx bit when stopping the PSC (prun = 0), and set them to appropriate value when starting the PSC (prun = 1), these bits are in the same PCTL register

Do not use the prescaler when a fault on one PSC should affect other PSC's

3. PSC: PAOCnA and PAOCnB Register Bits (Asynchronous output control)

These register bits are malfunctioning.

Workaround:

Do not use this feature.

4. PSC: PEVnA/B flag bits

These flags are set when a fault arises, but can also be set again during the fault itself.

Workaround:

Don't clear these flags before the fault disappears.

5. PSC: Output Polarity in Centered Mode

In centered mode, PSCOUTn1 outputs are not inverted, so they are active at the same time as PSCOUTn0.

Workaround:

Use an external inverter (or a driver with inverting output) to drive the load on PSCOUTn1.

6. PSC : POACnA/B Output Activity

These register bits are not implemented in rev A.

Workaround:

Do not use this feature.

7. VREF

Remark: To have Internal Vref on AREF pin select an internal analog feature such as DAC or ADC.

Some stand by power consumption may be observed if Vref equals AVcc

8. DALI

Some troubles on Dali extension when edges are not symmetric.

Workaround:

Use an optocoupler providing symmetric edges on Rx and Tx DALI lines (only recommended for software validation purpose).

9. DAC: Register Update

Registers DACL & DACH are not written when the DAC is not enabled.

Workaround:

Enable DAC with DAEN before writing in DACL & DACH. To prevent an unwanted zero output on DAC pin, enable DAC output, with DAOE afterwards.

10. DAC : Output spikes

During transition between two codes, a spike may appears

Work around:

Filter spike or wait for steady state

No spike appears if the 4 last significant bits remain zero.

11. DAC driver: Output Voltage linearity

The voltage linearity of the DAC driver is limited when the DAC output goes above Vcc - 1V.

Work around:

Do not use AVcc as Vref ; internal Vref gives good results

12. ADC : Conversion accuracy

The conversion accuracy degrades when the ADC clock is 1 & 2 MHz.

Work around:

When a 10 bit conversion accuracy is required, use an ADC clock of 500 kHz or below.

13. Analog comparator: Offset value

The offset value increases when the common mode voltage is above Vcc - 1.5V.

Work around:

Limit common mode voltage

14. Analog comparator: Output signal

The comparator output toggles at the comparator clock frequency when the voltage difference between both inputs is lower than the offset. This may occur when comparing signal with small slew rate.

Work around:

This effect normally do not impact the PSC, as the transition is sampled once per PSC cycle. Be carefull when using the comparator as an interrupt source.

15. PSC : Autolock mode

This mode is not properly handled when CLKPSC is different from CLK IO.

Work around:

With CLKPSC equals 64/32 MHz (CLKPLL), use LOCK mode

16. DALI : 17th bit detection

17th bit detection do not occurs if the signal arrives after the sampling point.

Workaround:

Use this feature only for software development and not in field conditions

17. PSC : One ramp mode with PSC input mode 8

The retriggering is not properly handled in this case.

Work around:

Do not program this case.

18. PSC : Desactivation of outputs in mode 14

See “PSC Input Mode 14: Fixed Frequency Edge Retrigger PSC and Disactivate Output” on page 155.

Work around:

Do not use this mode to deactivate output if retrigger event do not occurs during On-Time.

9.2 AT90PWM2B/3B

- **PSC : Double End-Of-Cycle Interrupt Request in Centered Mode**
- **ADC : Conversion accuracy**
- 1. **PSC : Double End-Of-Cycle Interrupt Request in Centered Mode**

In centered mode, after the “expected” End-Of-Cycle Interrupt, a second unexpected Interrupt occurs 1 PSC cycle after the previous interrupt.

Work around:

While CPU cycle is lower than PSC clock, the CPU sees only one interrupt request. For PSC clock period greater than CPU cycle, the second interrupt request must be cleared by software.

2. **ADC : Conversion accuracy**

The conversion accuracy degrades when the ADC clock is 2 MHz.

Work around:

When a 10 bit conversion accuracy is required, use an ADC clock of 1 MHz or below.

At 2 Mhz the ADC can be used as a 7 bits ADC.

3. **DAC Driver linearity above 3.6V**

With 5V Vcc, the DAC driver linearity is poor when DAC output level is above Vcc-1V. At 5V, DAC output for 1023 will be around 5V - 40mV.

Work around: .

Use, when $V_{cc}=5V$, V_{ref} below $V_{cc}-1V$.

Or, when $V_{ref}=V_{cc}=5V$, do not use codes above 800.

4. DAC Update in Autotrig mode

If the CPU writes in DACH register at the same instant that the selected trigger source occurs and DAC Auto Trigger is enabled, the DACH register is not updated by the new value.

Work around: .

When using the autotrig mode, write twice in the DACH register. The time between the two CPU writes, must be different than the trigger source frequency.

10. Datasheet Revision History for AT90PWM2/2B/3/3B

Please note that the referring page numbers in this section are referred to this document. The referring revision in this section are referring to the document revision.

10.1 Changes from 4317A- to 4317B

1. PSC section has been rewritten.
2. Suppression of description of RAMPZ which does not exist.

10.2 Changes from 4317B- to 4317C

1. Added AT90PWM2B/3B Advance Information.
2. Various updates throughout the document.

10.3 Changes from 4317C- to 4317D

1. Update of Electrical and Typical Characteristics.

10.4 Changes from 4317D to 4317E

1. Changed product status from “Advanced Information” to “Preliminary”.

10.5 Changes from 4317E to 4317F

1. Remove JMP and CALL instruction in the Instruction Set Summary
2. Daisy chain of PSC input is only done in mode 7 - See [“Fault events in Autorun mode” on page 160](#).
3. Updated [“Output Compare SA Register – OCRnSAH and OCRnSAL” on page 163](#)
4. Updated [“Output Compare RA Register – OCRnRAH and OCRnRAL” on page 163](#)
5. Updated [“Output Compare SB Register – OCRnSBH and OCRnSBL” on page 163](#)
6. Updated [“Output Compare RB Register – OCRnRBH and OCRnRBL” on page 164](#)
7. Specify the “Analog Comparator Propagation Delay” - See “DC Characteristics” on page 300.
8. Specify the “Reset Characteristics” - See [“Reset Characteristics\(1\)” on page 47](#).
9. Specify the “Brown-out Characteristics” - See [“Brown-out Characteristics\(1\)” on page 49](#).
10. Specify the “Internal Voltage Reference Characteristics - See [“Internal Voltage Reference Characteristics\(1\)” on page 51](#).

10.6 Changes from 4317F to 4317G

1. Describe the amplifier operation for Rev B.
2. Clarify the fact that the DAC load given is the worst case.
3. Specify the ADC Min and Max clock frequency.
4. Describe the retrigger mode 8 in one ramp mode.
5. Specify that the amplifier only provides a 8 bits accuracy.

10.7 Changes from 4317G to 4317H

1. Updated [“History” on page 2](#)
2. Specify the [“AREF Voltage vs. Temperature” on page 329](#)

3. PSC : the Balance Flank Width Modulation is done On-Time 1 rather than On-Time 0 (correction of figures)
4. Updated “Maximum Speed vs. VCC” on page 303 (formulas are removed)
5. Update of the “Errata” on page 23

10.8 Changes from 4317H to 4317I

1. Updated “History” on page 2
2. Updated “Device Clocking Options Select AT90PWM2B/3B” on page 31
3. Updated “Start-up Times when the PLL is selected as system clock” on page 35
4. Updated “ADC Noise Canceler” on page 241
5. Updated “ADC Auto Trigger Source Selection for non amplified conversions” on page 250.
6. Added “ADC Auto Trigger Source Selection for amplified conversions” on page 250
7. Updated “Amplifier” on page 252
8. Updated “Amplifier 0 Control and Status register – AMP0CSR” on page 256
9. Updated “AMP0 Auto Trigger Source Selection” on page 257
10. Updated “Amplifier 1Control and Status register – AMP1CSR” on page 257
11. Updated “AMP1 Auto Trigger source selection” on page 258
12. Updated DAC “Features” on page 259 (Output Impedance)
13. Updated temperature range in “DC Characteristics” on page 300
14. Updated V_{hysr} in “DC Characteristics” on page 300
15. Updated “ADC Characteristics” on page 306
16. Updated “Example 1” on page 315
17. Updated “Example 2” on page 315
18. Updated “Example 3” on page 316
19. Added “I/O Pin Input HysteresisVoltage vs. VCC” on page 322
20. Updated “Ordering Information” on page 17
21. Added Errata for “AT90PWM2B/3B” on page 25
22. Updated Package Drawings “Package Information” on page 18.
23. Updated table on page 2.
24. Updated “Calibrated Internal RC Oscillator” on page 33.
25. Added “Calibrated Internal RC Oscillator Accuracy” on page 302.
26. Updated Figure 27-35 on page 329.
27. Updated Figure 27-36 on page 330.
28. Updated Figure 27-37 on page 330.



Headquarters

Atmel Corporation
2325 Orchard Parkway
San Jose, CA 95131
USA
Tel: 1(408) 441-0311
Fax: 1(408) 487-2600

International

Atmel Asia
Room 1219
Chinachem Golden Plaza
77 Mody Road Tsimshatsui
East Kowloon
Hong Kong
Tel: (852) 2721-9778
Fax: (852) 2722-1369

Atmel Europe
Le Krebs
8, Rue Jean-Pierre Timbaud
BP 309
78054 Saint-Quentin-en-
Yvelines Cedex
France
Tel: (33) 1-30-60-70-00
Fax: (33) 1-30-60-71-11

Atmel Japan
9F, Tonetsu Shinkawa Bldg.
1-24-8 Shinkawa
Chuo-ku, Tokyo 104-0033
Japan
Tel: (81) 3-3523-3551
Fax: (81) 3-3523-7581

Product Contact

Web Site
www.atmel.com

Technical Support
Enter Product Line E-mail

Sales Contact
www.atmel.com/contacts

Literature Requests
www.atmel.com/literature

Disclaimer: The information in this document is provided in connection with Atmel products. No license, express or implied, by estoppel or otherwise, to any intellectual property right is granted by this document or in connection with the sale of Atmel products. **EXCEPT AS SET FORTH IN ATMEL'S TERMS AND CONDITIONS OF SALE LOCATED ON ATMEL'S WEB SITE, ATMEL ASSUMES NO LIABILITY WHATSOEVER AND DISCLAIMS ANY EXPRESS, IMPLIED OR STATUTORY WARRANTY RELATING TO ITS PRODUCTS INCLUDING, BUT NOT LIMITED TO, THE IMPLIED WARRANTY OF MERCHANTABILITY, FITNESS FOR A PARTICULAR PURPOSE, OR NON-INFRINGEMENT. IN NO EVENT SHALL ATMEL BE LIABLE FOR ANY DIRECT, INDIRECT, CONSEQUENTIAL, PUNITIVE, SPECIAL OR INCIDENTAL DAMAGES (INCLUDING, WITHOUT LIMITATION, DAMAGES FOR LOSS OF PROFITS, BUSINESS INTERRUPTION, OR LOSS OF INFORMATION) ARISING OUT OF THE USE OR INABILITY TO USE THIS DOCUMENT, EVEN IF ATMEL HAS BEEN ADVISED OF THE POSSIBILITY OF SUCH DAMAGES.** Atmel makes no representations or warranties with respect to the accuracy or completeness of the contents of this document and reserves the right to make changes to specifications and product descriptions at any time without notice. Atmel does not make any commitment to update the information contained herein. Unless specifically provided otherwise, Atmel products are not suitable for, and shall not be used in, automotive applications. Atmel's products are not intended, authorized, or warranted for use as components in applications intended to support or sustain life.

© 2008 Atmel Corporation. All rights reserved. Atmel®, logo and combinations thereof, and others are registered trademarks or trademarks of Atmel Corporation or its subsidiaries. Other terms and product names may be trademarks of others.